

Party Wall Design & Installation



PROFESSIONAL
SOLUTIONS



CSR

Contents

Introduction	2
Applications	2
Advantages	3
Gyprock Plasterboard Selection	4
Components	6
Design Considerations	9
Party Wall Overview	14
Typical Installation Sequence	15
Typical Construction Details	16
Service Penetrations	45
Party Wall Installation Checklist	46
Health & Safety	48
Warranty	48
Contact Details	48

Introduction

The CSR Gyprock Party Wall system is designed to provide a separating wall for dwellings that are side-by-side such as town houses and row houses.

Gyprock Party Wall comprises a double frame wall with a 25mm Shaft Liner Panel fire barrier between the frames. The basis of the fire performance is the central fire barrier that provides the primary fire resistance, with the frame lining on each side contributing to some extent. This allows the wall linings to be installed as for normal decorative linings, and to incorporate penetrations.

The basis of the acoustic performance is the double cavity system that provides effective sound transmission performance, as well as impact isolation. Insulation in both cavities is used to deliver a range of performance levels, including allowance for certain penetrations and services that may occur.

Applications

CSR Gyprock Party Wall intertenancy systems are designed as separating walls for Class 1 buildings. Systems are available for steel and timber framing with FRL 60/60/60 and sound ratings of $R_w + C_{tr} = 50$ or more. The systems have some elements that are common to the adjoining buildings, and are suitable for buildings with shared title on single allotments.

Systems for other classes of buildings, and for other Fire Resistance Levels are also available. Contact CSR Gyprock for information on construction for these systems.

Advantages

- Steel and timber frame options.
- Systems for $R_w + C_{tr}$ 50 and discontinuous construction.
- Room linings installed as for non-rated systems.
- No setting joints of central fire barrier.
- Shaft Liner MP suitable for mould resistance during construction.
- Services simply incorporated.
- Minimal use of sealants.
- Plasterboard and fibre cement options for wet areas.
- Rapid installation.
- No additional trades.

Figure 1: CSR Gyprock Party Wall Overview

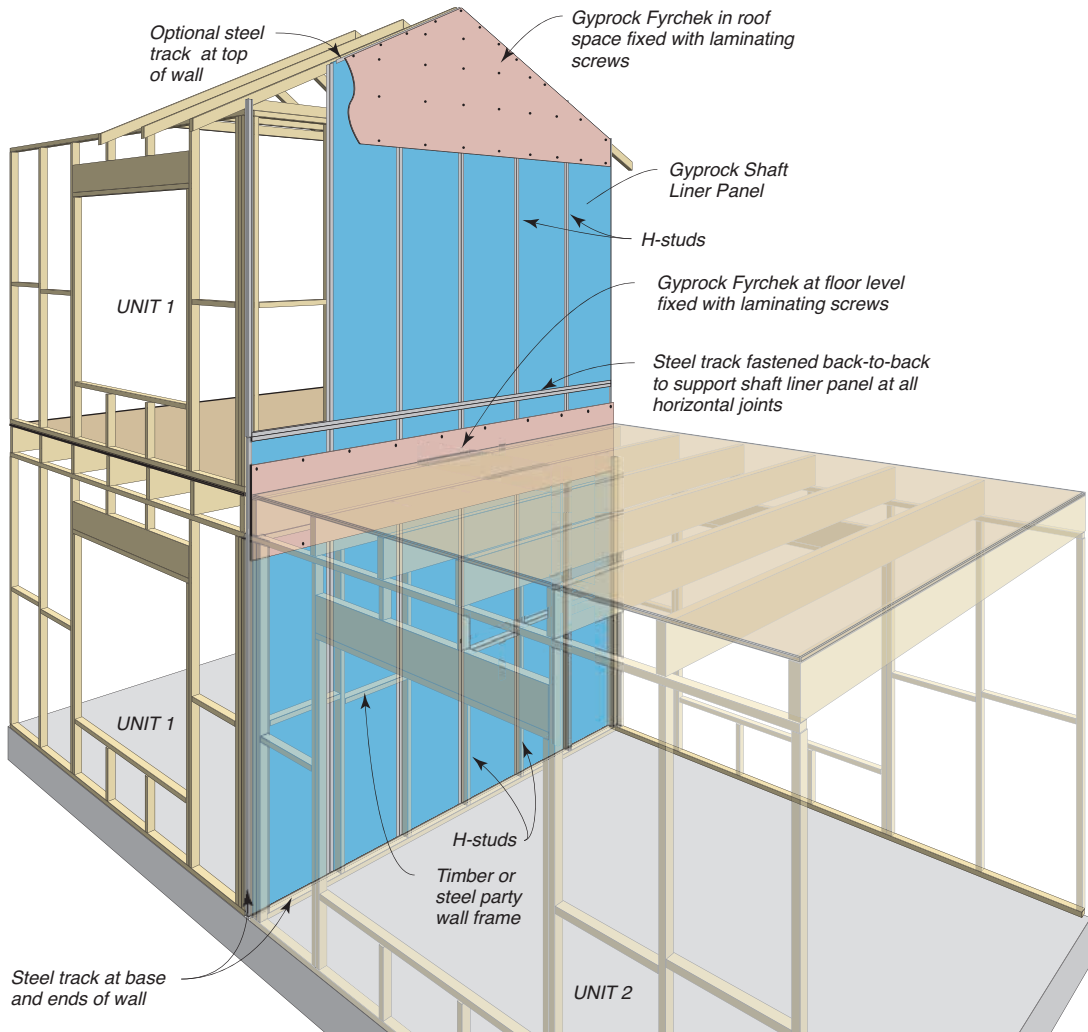
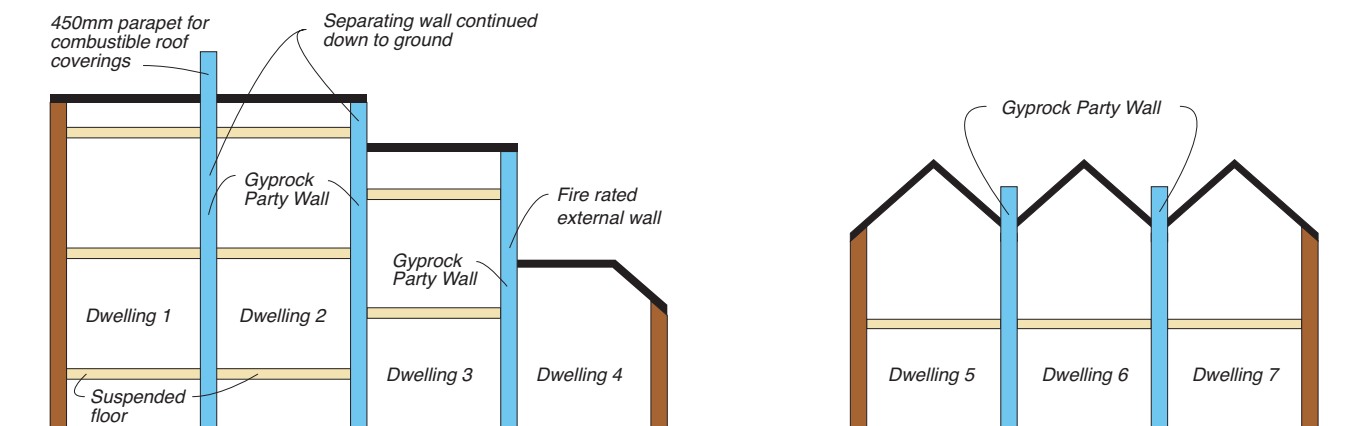

Figure 2: Typical Gyprock Party Wall Applications For Class 1 Buildings



Gyprock Plasterboard Selection

Gyprock plasterboard products are available in a large range of sheet lengths. Lengths vary by state, and a full list is available at www.gyprock.com.au. Standard width is 1200mm. Some products are also available in 900, 1350 and 1400mm widths (lead times may apply). Shaft Liner Panel is supplied in 600mm width only. Colour shading behind each product name approximates the colour of the product face liner sheet.

Table 1: Gyprock Plasterboard Features, Applications & Specifications









GYPROCK® PLASTERBOARDS	APPLICATIONS – WALLS & CEILINGS	THICK- NESS (mm)	MASS kg/m ²	FIRE GRADE	MOISTURE RESISTANT	ENHANCED IMPACT RESISTANCE	ENHANCED SOUND RESISTANCE	ENHANCED SOUND ABSORPTION	MOULD RESISTANT	LOW VOC	GECA ACCREDITED
	FEATURES										
RESIDENTIAL – SELECT RANGE											
Plus™	<ul style="list-style-type: none"> A 10mm thick sheet primarily designed for residential walls. Long edges are recessed to assist in producing a smooth, even and continuous surface once jointed. Made with Optimised Core technology that delivers an advanced performance-to-weight ratio, meaning greater breaking strength in a substantially lighter board that continues to exceed the performance requirements of AS/NZS2588. Optimised Core technology delivers improved handling and installed performance, as well as crisper score and snap. 	10	5.7							✓	
Supaceil™	<ul style="list-style-type: none"> A 10mm thick sheet designed to span up to 600mm in ceiling applications. Can also be used for wall applications. Long edges are recessed to assist in producing a smooth, even and continuous surface once jointed. Made with Optimised Core technology that delivers an advanced performance-to-weight ratio, meaning greater breaking strength in a substantially lighter board that continues to exceed the performance requirements of AS/NZS2588. Optimised Core technology delivers improved handling and installed performance, as well as crisper score and snap. 	10	6.1 6.2 WA only							✓	
Aquachek™	<ul style="list-style-type: none"> Both the core and linerboard facing are treated in manufacture to withstand the effects of moisture and high humidity. Recessed long edges allow flush jointing to other Recessed Edge plasterboard types. 	10	7.9		✓					✓	
RESIDENTIAL – SPECIALTY OPTIONS											
Superchek™	<ul style="list-style-type: none"> Manufactured with a very dense core and heavy duty facing producing high impact and sound resistance, Will span 600mm in ceiling applications. Double the force to impose a discernible surface indentation compared to standard plasterboard. Walls lined with Superchek provide a clearly noticeable reduction in perceived loudness compared to standard plasterboard. Long edges are recessed for flush jointing. 	10	10.4			✓	✓			✓	
COMMERCIAL – SELECT RANGE											
Standard Plasterboard	RE – Recessed Edge <ul style="list-style-type: none"> Long edges are recessed to assist in producing a smooth, even and continuous surface once jointed. 	13	8.5							✓	
	RE/SE – 1 Recessed Edge, 1 Square Edge <ul style="list-style-type: none"> Typically used on walls with a single horizontal joint. One long edge is recessed to assist in producing a smooth, even and continuous surface once jointed. One long edge is square to enable easy fixing of skirting and cornice at the top and bottom of walls. 	13	8.5							✓	
	SE – 2 Square Edges <ul style="list-style-type: none"> Long edges are square, and can be butted together without jointing, or covered with aluminium, timber or vinyl mouldings. 	13	8.5							✓	
Aquachek™	<ul style="list-style-type: none"> Both the core and linerboard facing are treated in manufacture to withstand the effects of moisture and high humidity. Recessed long edges allow flush jointing to other Recessed Edge plasterboard types. 	13	9.8		✓					✓	

Table 1: Gyprock Plasterboard Features, Applications & Specifications

GYPROCK® PLASTERBOARDS	APPLICATIONS – WALLS & CEILINGS	THICK- NESS (mm)	MASS kg/m ²	FIRE GRADE	MOISTURE RESISTANT	ENHANCED IMPACT RESISTANCE	ENHANCED SOUND RESISTANCE	ENHANCED SOUND ABSORPTION	MOULD RESISTANT	LOW VOC	GECA ACCREDITED
	FEATURES										
Soundchek™	<ul style="list-style-type: none"> Designed to provide enhanced acoustic resistance. A machine made sheet composed of a high density gypsum core encased in a heavy duty linerboard. Long edges are recessed for flush jointing. 	13	13.0				✓			✓	
Impactchek™	<ul style="list-style-type: none"> Fire grade board reinforced with a woven fibreglass mesh to produce a high strength plasterboard which resists soft body impact damage. Ideal for high traffic areas such as hallways, stairways, playrooms and garages. Long edges are recessed for flush jointing. 	13	10.5	✓		✓	✓			✓	
Fyrchek™	<ul style="list-style-type: none"> Fire grade board composed of a specially processed glass fibre reinforced gypsum core encased in a heavy duty linerboard. Ideal for high performance fire and acoustic rated walls and ceilings. Long edges are recessed for flush jointing. 	13	10.5	✓			✓			✓	
		16	12.5								✓
Fyrchek™ MR	<ul style="list-style-type: none"> Fire grade board with moisture resistant properties. Both the core and the liner board are treated in manufacture to withstand the effects of high humidity and moisture. Long edges are recessed for flush jointing. 	13	10.8	✓	✓		✓			✓	
		16	12.9								✓
COMMERCIAL – SPECIALTY OPTIONS											
EC08™ Impact	<ul style="list-style-type: none"> This product features higher levels of recycled content, making it a superior choice for Green Building projects. EC08 Impact is a fire grade board offering increased density for greater resistance to soft and hard body impact for high traffic areas such as hallways and stairs in education and health facilities. Long edges are recessed for flush jointing. 	13	12.1	✓		✓	✓			✓	
EC08™ Impact MR	<ul style="list-style-type: none"> This product features higher levels of recycled content, making it a superior choice for Green Building projects. A fire grade board specially treated for wet area/high humidity locations subject to increased impact risk, such as bathrooms, kitchens, laundries, walkways for hospitals, aged care, educational and commercial buildings. Long edges are recessed for flush jointing. 	13	12.4	✓	✓	✓	✓			✓	
EC08™ Complete	<ul style="list-style-type: none"> This product features higher levels of recycled content, making it a superior choice for Green Building projects. Gyprock EC08 Complete is a premium internal lining solution which integrates an efficient mould inhibitor, scuff resistance, soft and hard body impact resistance, moisture resistance, sound resistance and fire resistance into a low VOC plasterboard. Long edges are recessed for flush jointing. 	13	12.4	✓	✓	✓	✓		✓	✓	
		16	14.8								✓
Shaft Liner Panel	<ul style="list-style-type: none"> Fire grade board used extensively in Gyprock shaft systems, services systems, party wall and intertenancy wall applications. A 25mm thick sheet composed of a glass fibre reinforced gypsum core encased in a heavy duty linerboard. 600mm wide square edge sheets. 	25	19.8	✓			✓			✓	
Shaft Liner Panel MP	<ul style="list-style-type: none"> Fire grade board with antifungal additives to resist mould formation. A 25mm thick sheet composed of a glass fibre reinforced gypsum core encased in a heavy duty ivory linerboard. 600mm wide square edge sheets. 	25	19.8	✓			✓		✓	✓	
Flexible	<ul style="list-style-type: none"> A 6.5mm thick plasterboard with an enhanced core to allow bending to small radii for curved walls and ceilings. Designed for installation as a two layer system. Long edges are recessed for flush jointing. 	6.5	4.3							✓	
Glasroc F	<ul style="list-style-type: none"> A 30mm thick paperless gypsum board with glass fibre reinforced core. Designed for single-layer installation, without jointing, to provide fire protection to structural steel columns and beams. 1200mm wide square edge boards. 	30	25.5	✓		✓					

Components

Fasteners

Fasteners For Fixing Clips/Straps to Timber Framing

- Type S, bugle head, needle point, coarse thread screw.

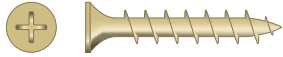

Size	Pack	Qty	Order No.
6g x 25mm (softwood/hardwood)	Loose	1000	169067
	Collated	1000	162775

- Clouts, hot-dip galvanised for fixing Wall Clip and Aluminium Straps to timber plate.



Size (Framing)	Pack	Qty	Order No.
2.8 x 25mm (softwood/hardwood)	Loose	0.5kg	77267

Screws For Fixing Components To Steel Framing

- Drill-point, wafer-head screw for joining J-track back-to-back, for fixing Wall Clips, Aluminium Straps and J-tracks to steel framing.

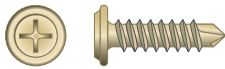

Size	Pack	Qty	Order No.
10g x 16mm	Loose	1000	169079

- Drill-point, wafer-head screw for fixing Wall Clip to H-Stud through Gyprock Fyrchek plasterboard.

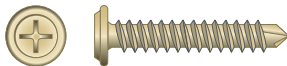

Size	Pack	Qty	Order No.
10g x 30mm	Loose	500	169080

- Type S plasterboard laminating screw, coarse thread, for fixing 16mm Gyprock Fyrchek plasterboard to Shaft Liner Panels.

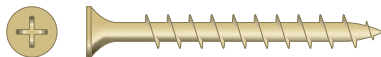

Size	Pack	Qty	Order No.
10g x 38mm	Loose	500	109259

Bottom Plate Fasteners

- Steel fasteners, supplied by others.

Gyprock Acrylic Stud Adhesive

- Gyprock Acrylic Stud Adhesive is coloured blue for easy identification. It can be used in temperatures not less than 5°C.
- Contact surfaces must be free of oil, grease or other foreign materials before application. The adhesive is applied with a broad knife to form 25mm diameter by 15mm high walnuts. This product is suitable for use with pre-painted metal battens and some treated timbers. Always follow directions on packaging.

WARNING

- Stud adhesive must not be relied on in fire rated systems.
- Daubs of adhesive must never coincide with fastener points.
- Stud adhesive does not constitute a fixing system on its own and it must be used in conjunction with nail or screw fasteners.



Pack	Qty	Order No.
Sausage	900g	95082
Bucket	5.5kg	10091

Sealants

- Gyprock Fire Mastic fire rated sealant for use where detailed.



Pack	Qty	Order No.
Sausage	600ml	10924

- CSR FireSeal fire rated sealant for use where detailed.



Pack	Qty	Order No.
Sausage	600ml	121022

- Gyprock Wet Area Acrylic Sealant.



Pack	Qty	Order No.
Tube	450g	10902

Steel H-Stud

The Gyprock Party Wall System incorporates 25mm H-Studs to support the Shaft Liner Panels at all vertical joints. It is made from 0.55mm BMT G275 galvanised steel.

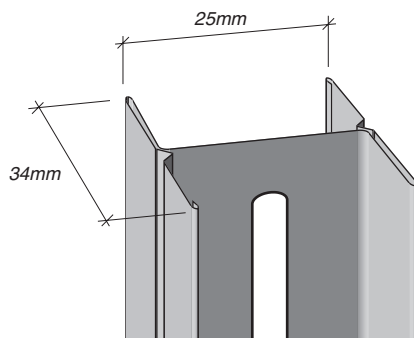

Length	Order N°
3000mm	39156
3600mm	122926

Gyprock Aluminium Wall Clip and Strap

- Used to support the H-Stud, and are critical in the fire performance of systems. They are manufactured from 1.6mm aluminium.

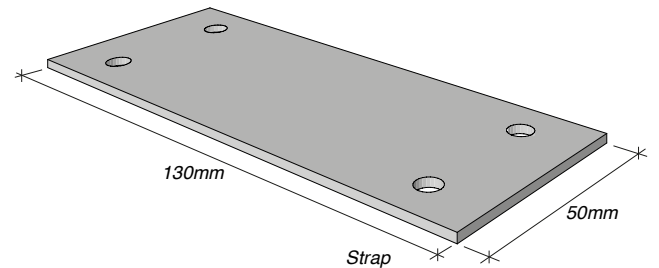
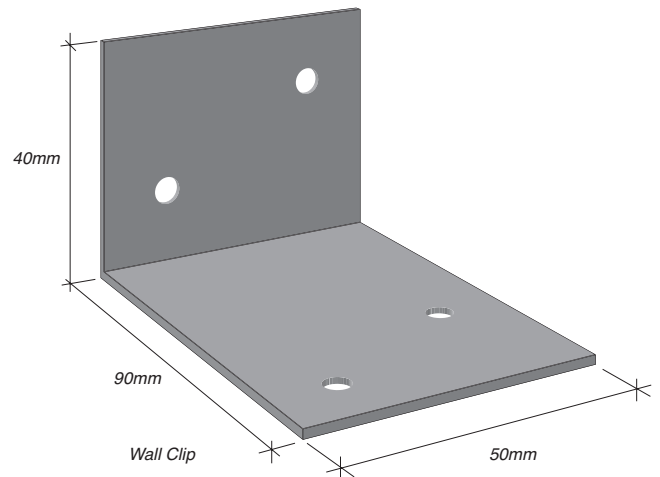

Item	Size	Order N°	Pack Qty
Clip	40 x 90 x 50mm	454513	1
Strap	130 x 50mm	193172	1

J-track

Steel J-track (Rondo N°P140) is used in the following applications:

- Support of Shaft Liner Panels at the top and the bottom of the wall.
- Support of Shaft Liner Panels at the ends of the wall.
- Back-to-back at all horizontal joints in Shaft Liner Panels.
- Base of wall at cantilever.

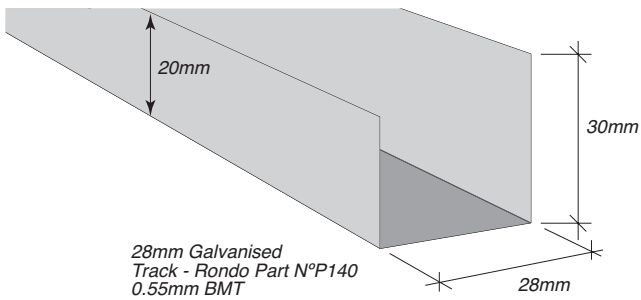

Length	Order N°
3000mm	10465

Typical application detail.

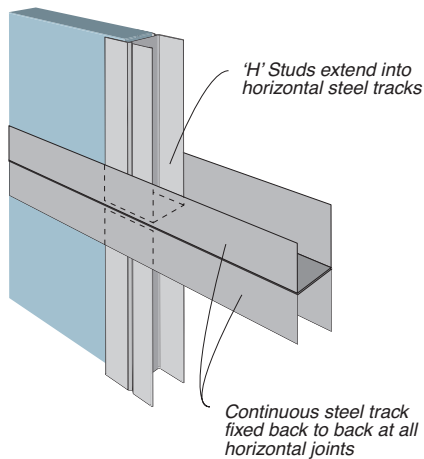

Insulation Materials

CSR Fire and Acoustic Systems incorporate Bradford glasswool and rockwool insulation. These products have undergone significant acoustic testing and have a proven track record of performance and durability in service. Additional information on Bradford Insulation materials is available by telephoning CSR Bradford on 1300 850 305.

Although insulation materials are often specified for thermal resistance, they can contribute significantly to the acoustic performance of wall and ceiling systems. CSR only recommends materials that have been tested for fire and acoustic applications, have proven durability, and are supported by their manufacturer for these applications. Should other insulation materials be used, the manufacturer of those materials must verify the performance of the complete system, CSR will not support the performance of substitute materials.



Product	Abbreviation
75mm Bradford Gold Wall Batts R2.0	75 Gold Batts 2.0
90mm Bradford Gold Wall Batts R2.7	90 Gold Batts 2.7
50mm Bradford Acoustigard R1.3 (14kg/m ³)	50 GW Acoustigard 14kg
75mm Bradford Acoustigard R1.8 (14kg/m ³)	75 GW Acoustigard 14kg
110mm Bradford Acoustigard R2.5 (11kg/m ³)	110 GW Acoustigard 11kg
88mm Bradford Soundscreen R2.5	88 Soundscreen R2.5

Cavity seals noted as rockwool must be of minimum density 50kg/m³ such as Bradford Party Wall Sealer.

GeminSeal Wallboard

GeminSeal Wallboard features an embedded micro waterblock technology that repels water, preventing water penetration into the panel and hence providing a durable sheet that will not rot, swell or warp when properly installed.

Wallboard is a superior lining for wet areas such as bathrooms and laundries, and for the construction of impact resistant walls. Cemintel Wallboard has a recess on both long edges so that sheets may be taped and set. Once jointed it may be tiled, painted or wall papered as desired.

Design Considerations

Building Design

Gyprock Party Wall systems consist of vertically spanning elements, typically extending from the ground slab or footing to the roof. Where walls extending upwards from other levels are permitted, details are available, for example from a cantilevered balcony. It may not be possible to start the Party Wall system over a void or above cavity masonry while maintaining both fire and acoustic ratings. Consideration of roof framing is also important to avoid penetrating the fire barrier with trusses, ties, hip beams, etc.

Maximum overall height for the central fire barrier is 14m with Party Wall Clips at 2.7m maximum centres, and up to 12m high with Clips at maximum 3.0m centres. Refer to Table 2 other options. Where wall heights (floor/ceiling or floor/roof) are over 3.0m, Party Wall Clips are required for lateral restraint of the central core. Clips in locations other than floor or ceiling junctions do not meet the requirement for discontinuous construction, which may be acceptable in some rooms. They will also reduce the acoustic rating of the wall. Refer to Table 3 for details.

Table 2: Lateral support locations for total wall height

Total Wall Height	'H'
Up to 14m	max. 2.7m
Up to 12m	max. 3.0m
Up to 10.8m	max. 3.2m
Up to 9m	max. 3.6m

Details are provided to allow the adjoining buildings to be offset in height, with the higher-level walls treated as fire rated external walls. Gyprock Party Wall systems are suited to buildings with aligned facades, and details for off-set facades are also provided.

Figure 3: Maximum Panel & Wall Height Details

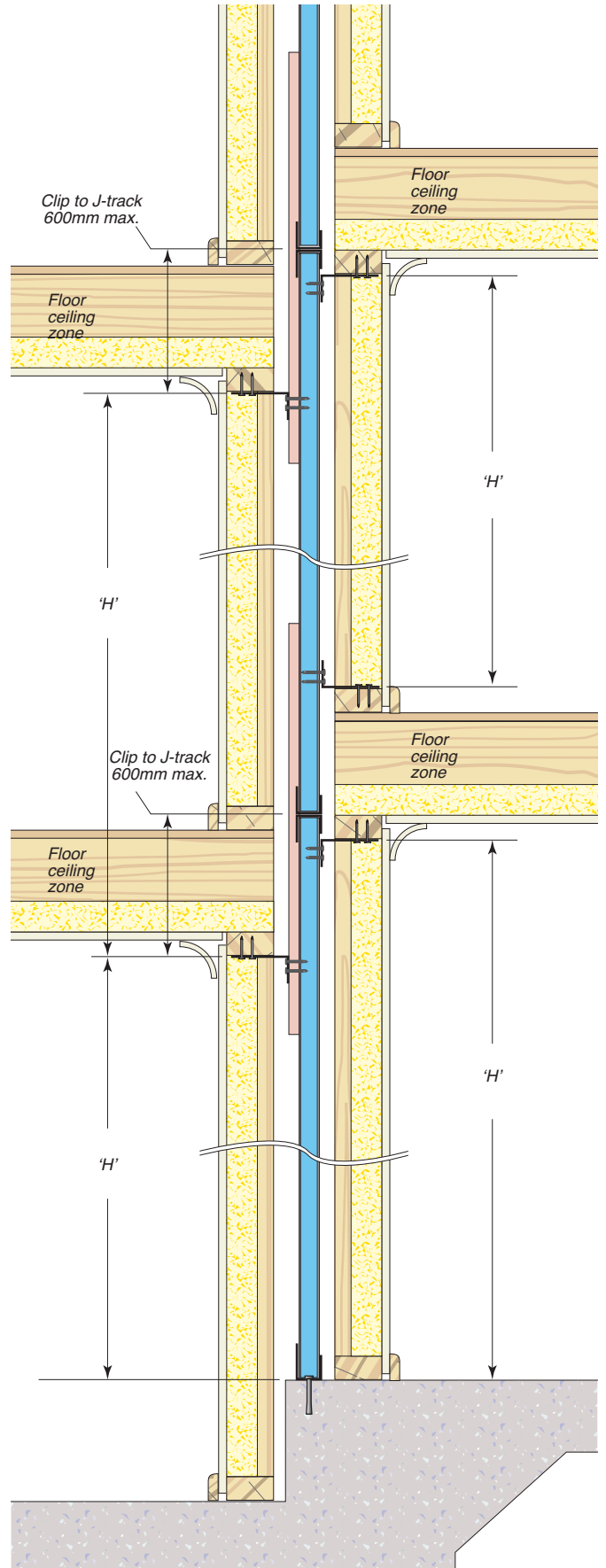

Figure 4: Details for Wall Height up to 14m

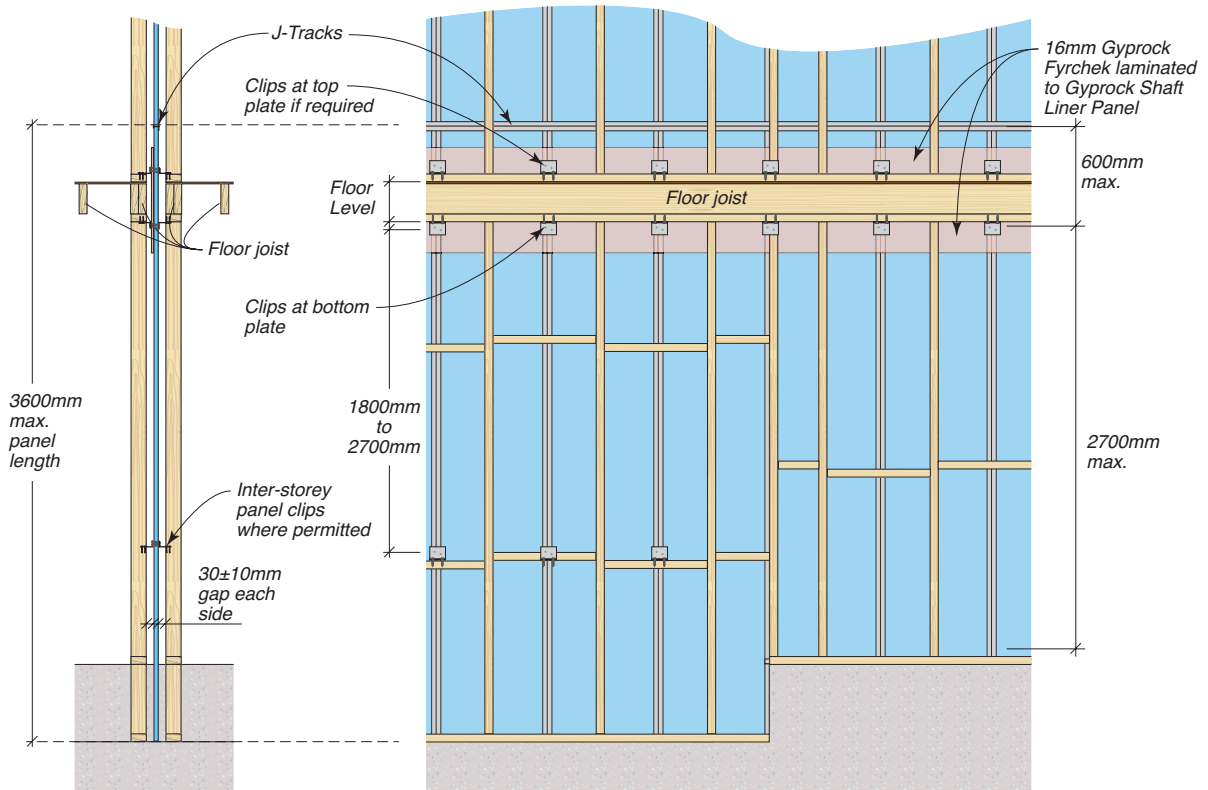
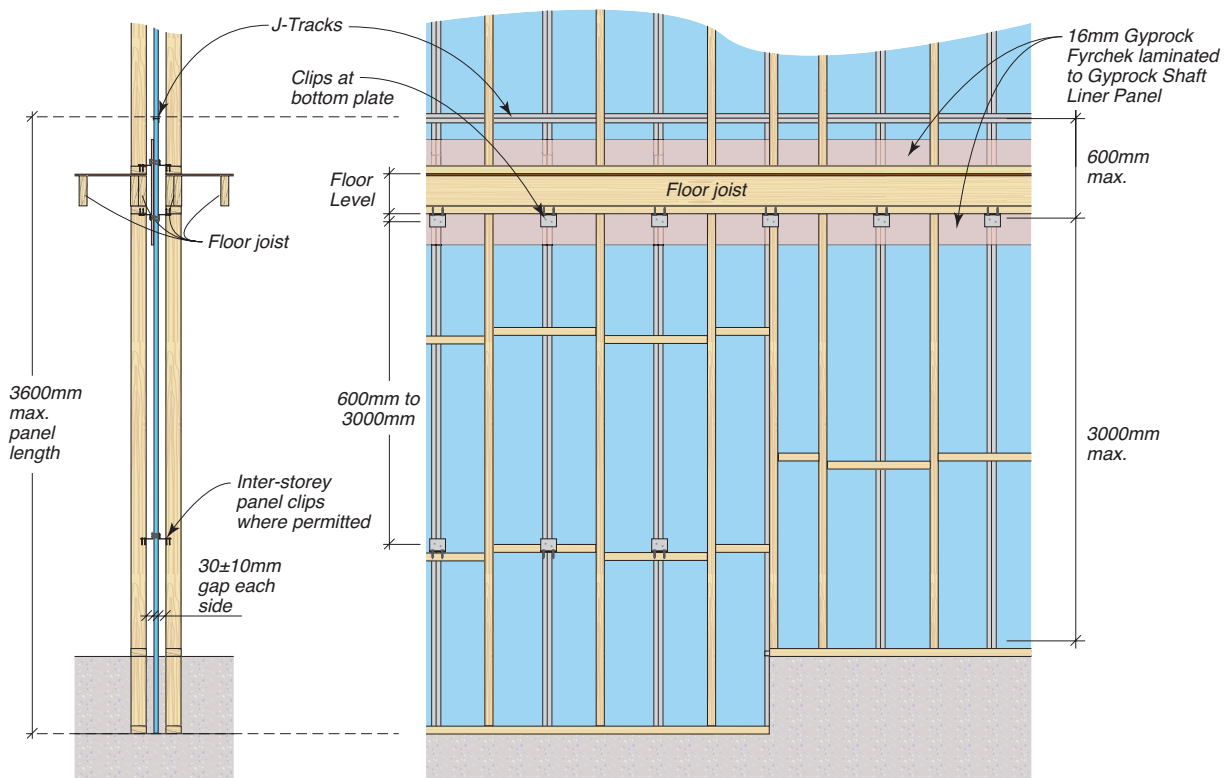

Figure 5: Junction for Wall Height up to 12m



Structural Design

All walls must be designed for the applied loads, including seismic loads where applicable. Timber framing shall be in accordance with AS1684 or AS1720.1 and steel framing shall be designed to AS/NZS 4600 or AS 3623. The building designer must ensure load-bearing walls have been designed assuming no contribution to axial strength from the wall linings.

Gyprock Party Wall Systems may be exposed to wind during construction for up to three months during construction, for wind zones N1 and N2. For higher wind loads or longer exposure, the H-Studs must be adequately propped until the building is enclosed.

Installation of System Wall Clips and Straps

Aluminium Wall Clips used in the system allow gaps of 20mm to 40mm between the wall framing and the Shaft Liner panel. Areas with 16mm Fyrchek laminated to one side of the Shaft Liner may have the gap reduced to 4mm. In all areas, suitable allowance for construction tolerance should be made to ensure the minimum gap is maintained.

Clips must be screw fixed to H-stud or J-track framing, and fixing directly to the Shaft Liner Panel is not permissible. Each Clip is also fixed to the wall framing at plates/tracks, trimmers, noggins or trusses. They may be fixed to framing studs if the alignment permits.

Aluminium Straps may be used instead of Wall Clips at terminating junctions.

System Selection

Refer to Gyprock The Red Book Volume 1 for an extensive range of systems with associated fire and acoustic performance values. Options are available for wet areas, for rooms requiring damage resistance, and for premium acoustic ratings.

Fire Resistance

The Gyprock Party Wall systems in this manual have been assessed by Exova Warringtonfire in accordance with the general principles of AS1530.4. They are suitable for the stated FRL when designed in accordance with the noted building and structural considerations, and when installed in accordance with the details in this manual. The load bearing element of the FRL applies only to walls supporting non-fire rated structures such as floors and roofs within the same fire compartment.

The systems are designed to allow one side to collapse in a fire, leaving the central barrier and the opposing wall in place. In the roof space and the floor/ceiling zone where there are no stud linings, 16mm Fyrchek plasterboard is laminated to the Shaft Liner to maintain the rating. The aluminium clips used in single Shaft Liner systems are intended to melt on the fire side only, allowing collapse without damage to the remaining system.

For all systems, penetrations may be made in Shaft Liner Panels in the roof space only, and must be fire sealed to suit the system fire rating.

Systems lined with Cemintel Wallboard must include Bradford glasswool or rockwool insulation to each frame to achieve the stated fire resistance.

Details for the perimeters of Party Walls adjoining roof and wall claddings are provided using rockwool or fire grade sealants. Where rockwool is used it must be compressed lightly to fill the gap between the cladding and Shaft Liner or J-Track. Rockwool batts may be trimmed to suit the gap dimensions. Fire grade sealant is used between the J-Track and sheet cladding, over any wall wrap

Acoustic Performance

The acoustic performance of wall systems is expressed in terms of R_w and $R_w + C_{tr}$. The systems have been assessed by PKA Acoustic Consulting, and the ratings refer to expected laboratory performance. The site performance of the systems may be affected by sound flanking, the effectiveness of workmanship, and the inclusion of structural elements and bridging items. The building designer must pay special attention to airborne and structural flanking paths to minimise the difference between laboratory and field performance.

Wall clips are only to be installed at or within floor and ceiling zones as shown in the details. Using additional clips within the storey height will reduce the acoustic performance of the wall, and may not meet the requirement for discontinuous construction.

Refer to Table 3 for system performance where an additional row of Party Wall clips is used.

For flanking sound control, it is required that the ceiling of each story consists of plasterboard 10mm or thicker, and that the floor and roof spaces are at least 250mm in height. Insulation is required in the floor and roof space, extending 1200mm minimum on each side of the wall over the ceiling. The insulation is to be glasswool or rockwool 75mm or thicker, such as Bradford R1.5 Gold batts. Similarly for flanking at the junction of the party wall with clad external walls, the external wall's interior lining must be a minimum of 10mm Gyprock plasterboard. The cavity of the external wall on each side of the party wall must be filled with insulation of at least 75mm Bradford R1.5 Gold batts for a distance of 600mm.

Ceiling penetrations must be acoustically treated in areas closer than 1.2m of Party Walls, except for LED downlights. These must be no closer than 900mm apart, with penetrations neat and tight to the fitting.

It is assumed no rating is required between the two adjoining roof or floor spaces and that the spaces are not able to be occupied. It is proposed that the detail is an alternative solution, and is to be confirmed by the certifier.

All systems achieve $R_w > 45$ and $R_w + C_{tr} > 40$ for services in the adjoining unit.

Table 3: Acoustic rating of systems with inter-storey clips.
Refer to detail

System	Stud Depth	70	90
	Cavity Infill Both Sides	R _w /R _w +C _{tr}	
CSR 2402	90 Gold batts 2.7	61/48	62/ 50
	88 Soundscreen 2.5	62/49	63/ 51
CSR 2405	90 Gold batts 2.7	62/49	63/ 51
	88 Soundscreen 2.5	63/ 50	64/ 52
CSR 2441	90 Gold batts 2.7	61/48	62/ 50
	88 Soundscreen 2.5	62/49	63/ 51
CSR 2445	90 Gold batts 2.7	62/49	63/ 51
	88 Soundscreen 2.5	63/ 50	64/ 52
CSR 1523	88 Soundscreen 2.5	61/48	63/ 50
CSR 1535	75 Acoustigard 14	62/ 50	63/ 51

Substitution

Plasterboard, fibre cement, and insulation materials must be as specified in the construction details and system selection tables. No statement of performance will be provided by CSR when other brand products are used.

Exposure to Weather

Once erected, it is recommended that the central barrier of Gyprock Shaft Liner Panels and Fyrchek plasterboard are protected from rain. The use of a covering can prevent the formation of mould, and can avoid delays in allowing boards to dry before internal linings are applied. The use of Shaft Liner Panel MP is recommended to reduce the occurrence of mould during the construction period. In any case, the central barrier may be left exposed to weather for up to one month if required. Panels with physical damage to either the core or paper face must be replaced.

Fibre Cement & Plasterboard Fixing

Walls may be built to achieve a specified 'Level of Finish' as defined in AS/NZS2589. The Level of Finish specified can have requirements for frame alignment, jointing and back blocking methods, and sheet orientation.

CeminSeal Wallboard and Gyprock plasterboard may be installed vertically or horizontally, although for some Levels of Finish horizontal sheeting must be used. Walls lined with Gyprock plasterboard or CeminSeal Wallboard may be finished with tiles. Refer to the appropriate installation manual:

- The Red Book #2 - Residential Installation Guide
- The Red Book #3 - Commercial & Multi-Residential Installation Guide
- Cemintel Wet Area Systems
- Cemintel Texture Base Sheet Installation Guide

Fyrchek Laminated Layer

The installation of Fyrchek laminated to the central Shaft Liner barrier is required in some areas, including:

- The roof space.
- Floor framing junctions.
- The sub-floor space.
- The eaves space (when using party wall eaves separation method).
- Cantilevered wall locations.
- Other areas where wall linings are omitted such as at built-in baths.

The laminated layer must extend vertically at least 200mm beyond any unlined area and may be installed on either side of the Shaft Liner panel. It should not be installed on both sides in any location where discontinuous construction is required.

Vertical joints between sheets should be positioned so that they do not coincide with vertical H-stud locations. The sheet joins must be neatly formed, and gaps up to 3mm wide need not be filled or set.

The Fyrchek laminated layer must be fixed with laminating screws at spacings detailed the installation diagram.

Services

CSR Gyprock Party Wall systems allow penetrations to be made in the stud wall linings. Back-to-back services are permitted. Penetrations for plumbing and electrical services may be installed without the need for acoustic caulking, baffles or fire seals.

No penetrations are permitted through the central fire barrier, except within the roof space where they must be fire sealed.

Systems have been fire tested with services including PVC (65mm max. diameter), copper plumbing, GPO's and electrical services installed in both wall leaves with acceptable performance. Services may be installed through the stud framing or, with a minimum 10mm clearance to the central Shaft Liner barrier, and may be fixed to the back of studs. Simply prepare neat cut holes with a 6mm maximum clearance.

Bath tubs may be built-in on each side of a Party Wall system as detailed without reducing the acoustic performance. The bath material must consist of steel at least 1.0mm thick, or acrylic of at least 5.0mm thick.

No fire or acoustic sealant is required at junction of shaft liner panel with H-Studs or between the track and an even floor slab. No fire caulking is required in the outer linings.

Figure 6: Typical Penetration Features

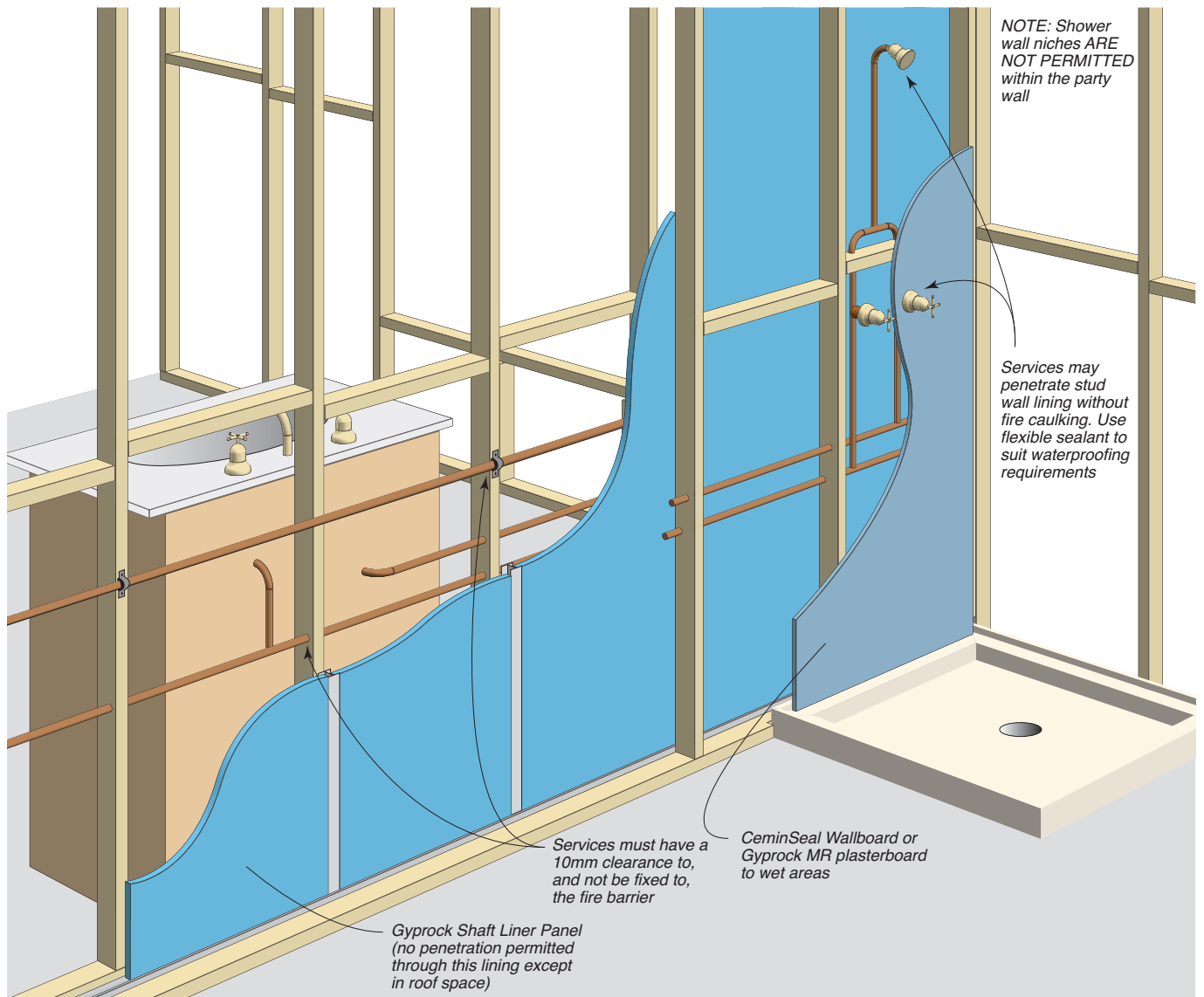

Party Wall Overview

**Roof and ceiling details.
Refer to Figure 46**

**Eaves details.
Refer to Figure 51**

**Roof and ceiling details.
Refer to Figure 50**

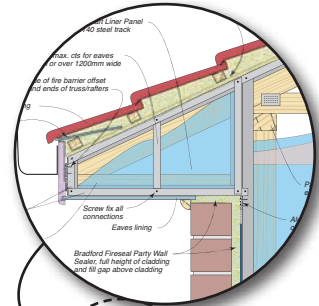
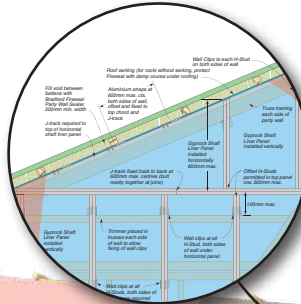
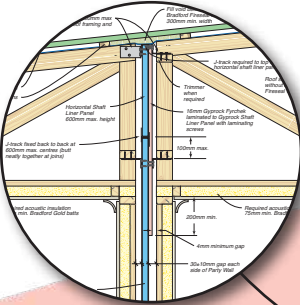

**Party Wall Junction details.
Refer to Figure 4**

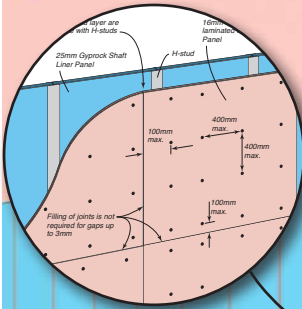

**Cantilevered level soffit details.
Refer to Figure 69**

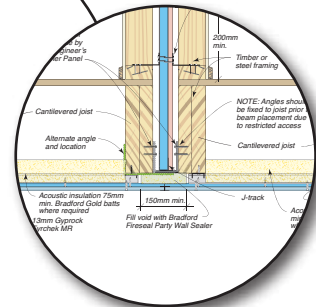

**Junction of Party Wall and external walls.
Refer to Figure 55**

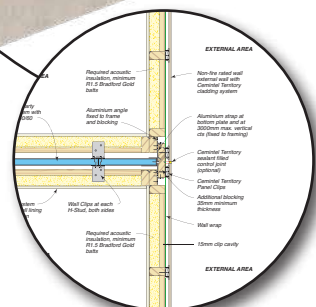

**Step down details.
Refer to Figure 49**

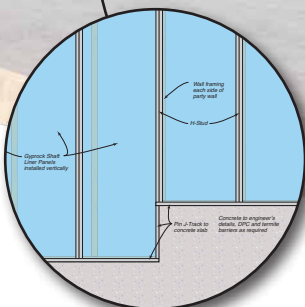

**Base details.
Refer to Figure 11**

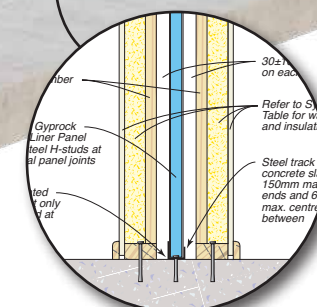

Typical Installation Sequence

A typical construction sequence consists of installation of framing for an occupancy on one or more levels, installation of the Party Wall central barrier, and installation of the second occupancy framing. An alternative sequence is to erect framing for both occupancies and then to insert the Party Wall central barrier. In this case sufficient access must be provided to install all wall components by, for example, temporarily omitting some framing.

Figure 7: Ground Floor Fire Barrier Installed

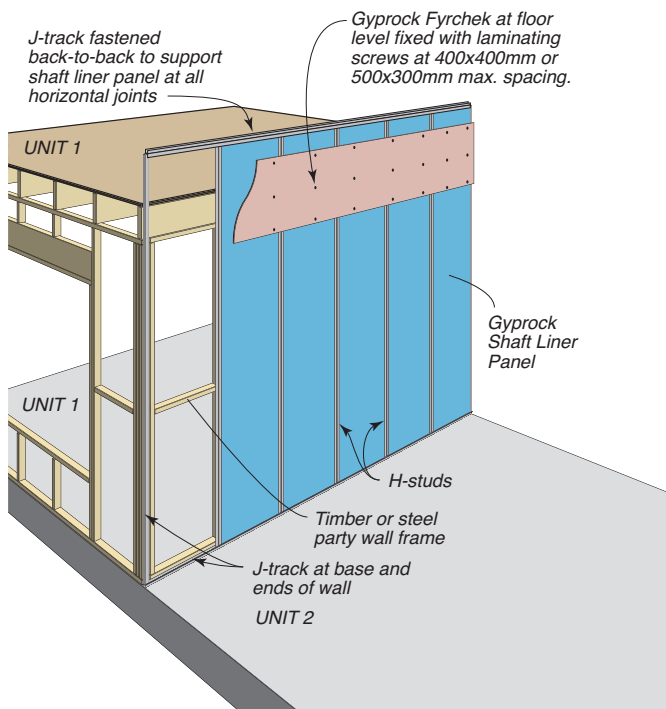

Figure 8: Unit 2 Frame And Floor Installed

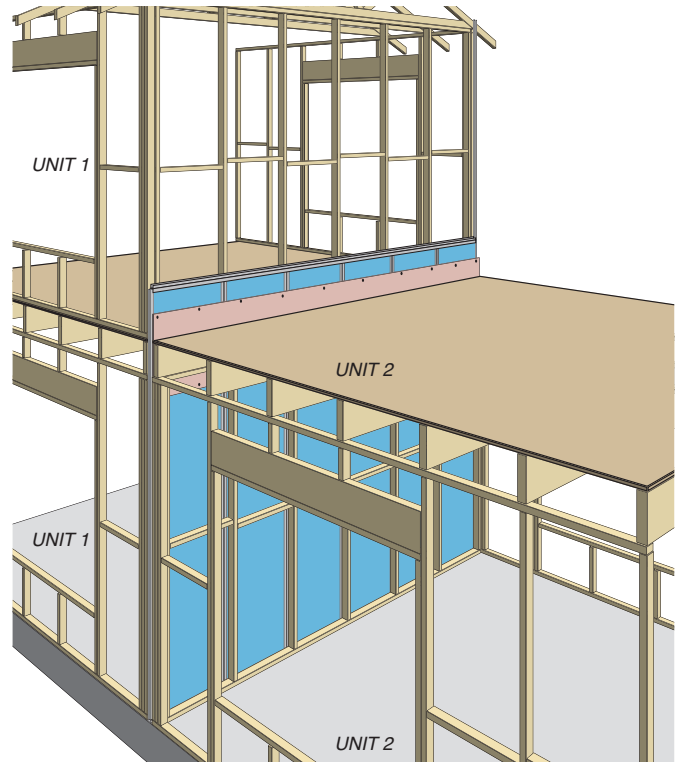

Figure 9: First Floor Fire Barrier Installed

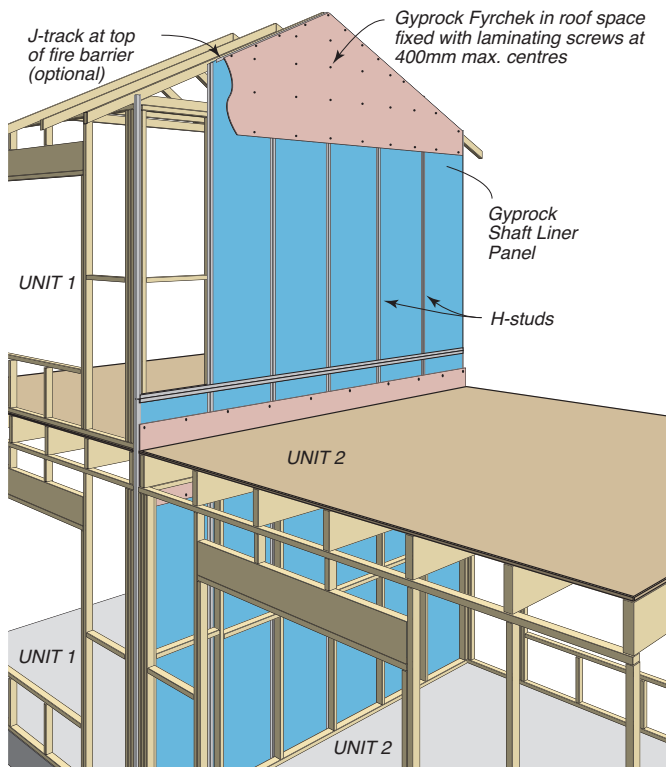
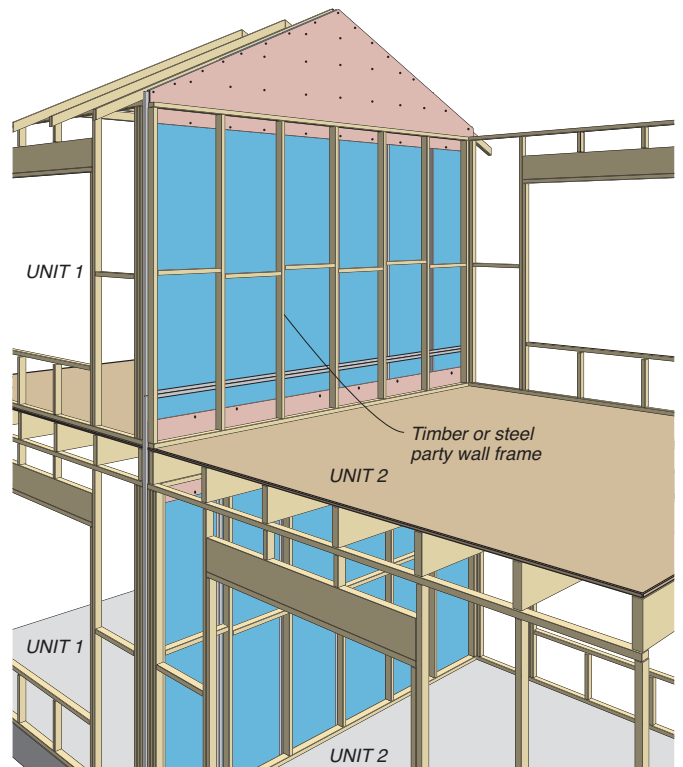

Figure 10: Unit 2 First Floor Framing Installed



Typical Construction Details

Fire appraisal WFR A 45743, unless noted otherwise.

Figure 11: Base At Flat Slab With Pinned J-Track

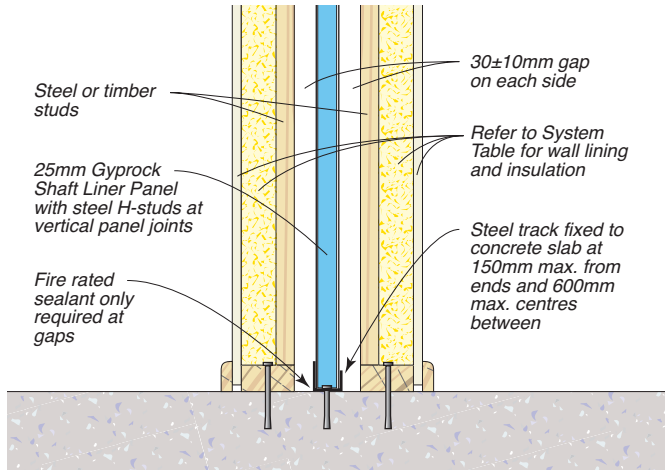

Figure 12: Alternative Base With Clips

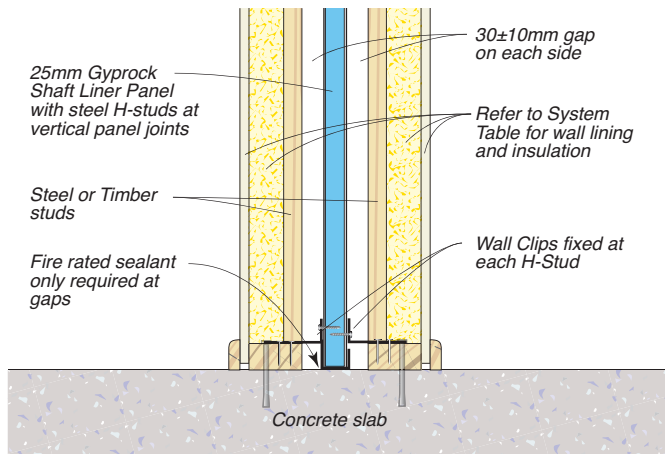

Figure 13: Base Detail At Framed Floor

Approval: EWFA 45743 UNO

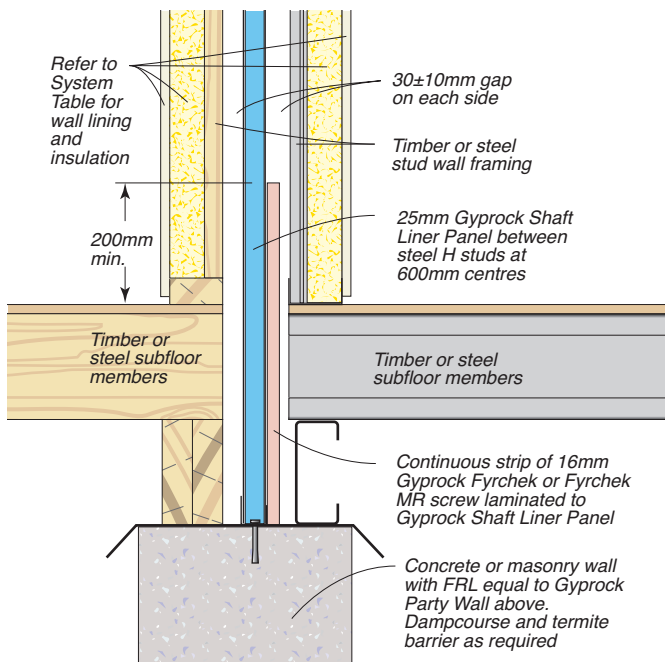

Figure 14: Base At Stepped Slab

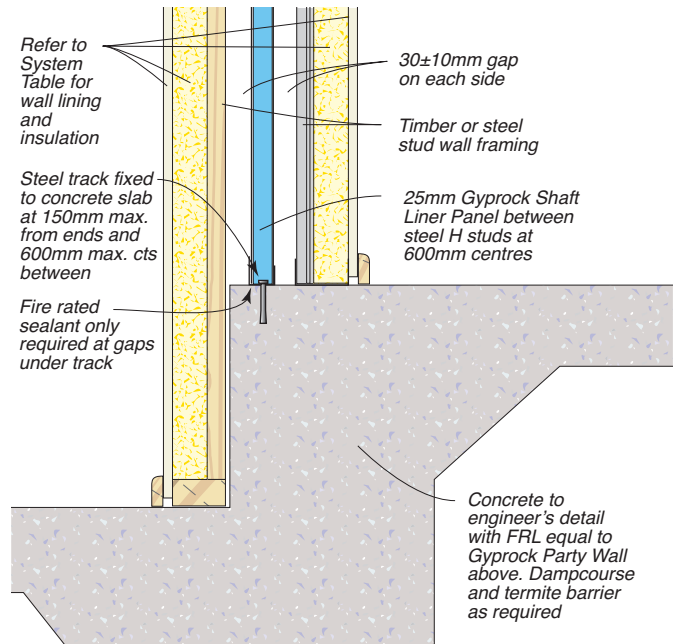

Figure 15: Base At Stepped Slab

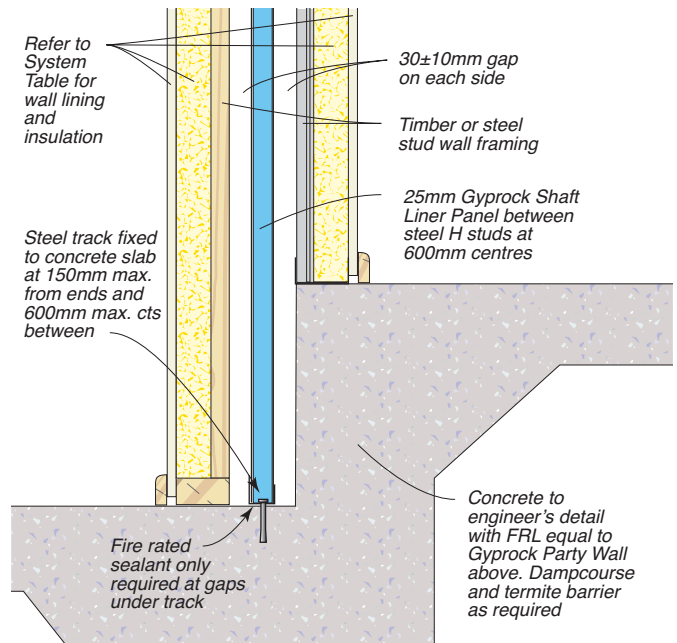

Figure 16: Party Wall over Masonry Wall – Plan View

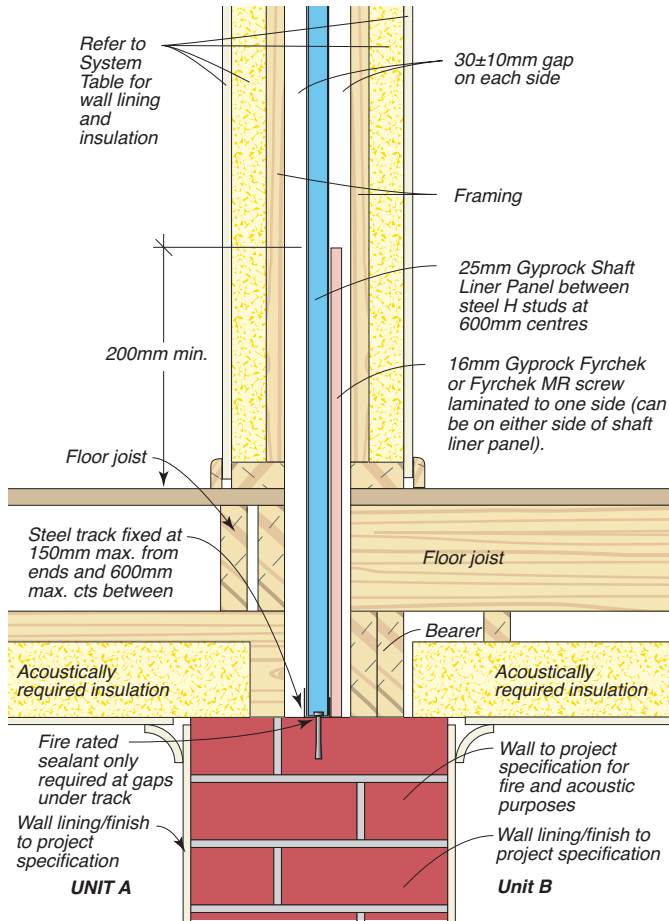

Figure 17: Bath Installation - Elevation

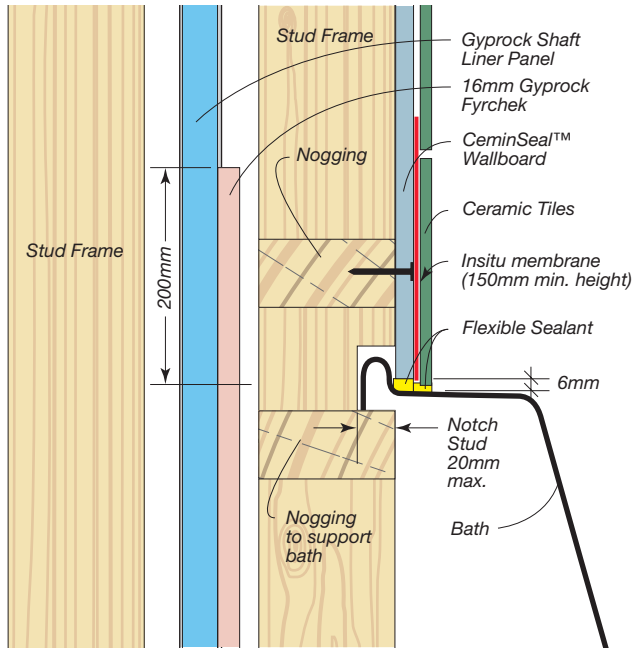

Figure 19: Alternative Tub/Basin install (Discontinuous linings) - Elevation

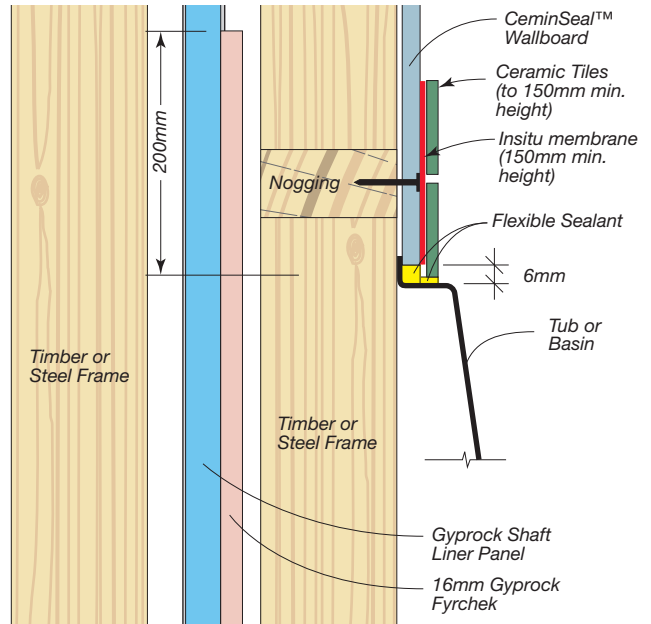

Figure 18: Laundry Tub/Basin Installation (continuous linings) - Elevation

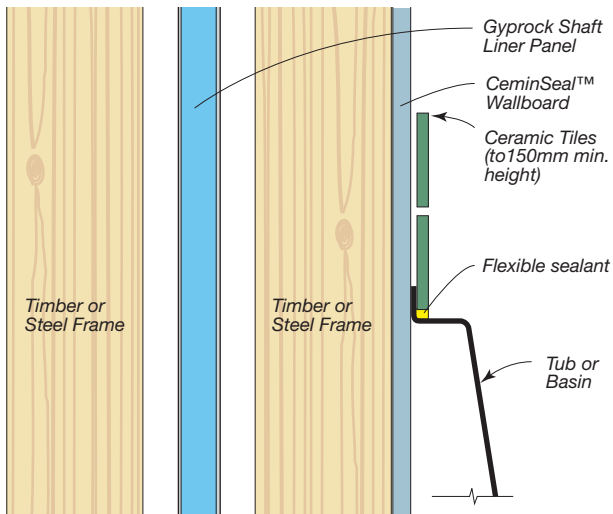

Figure 20: Bath Installation - Elevation

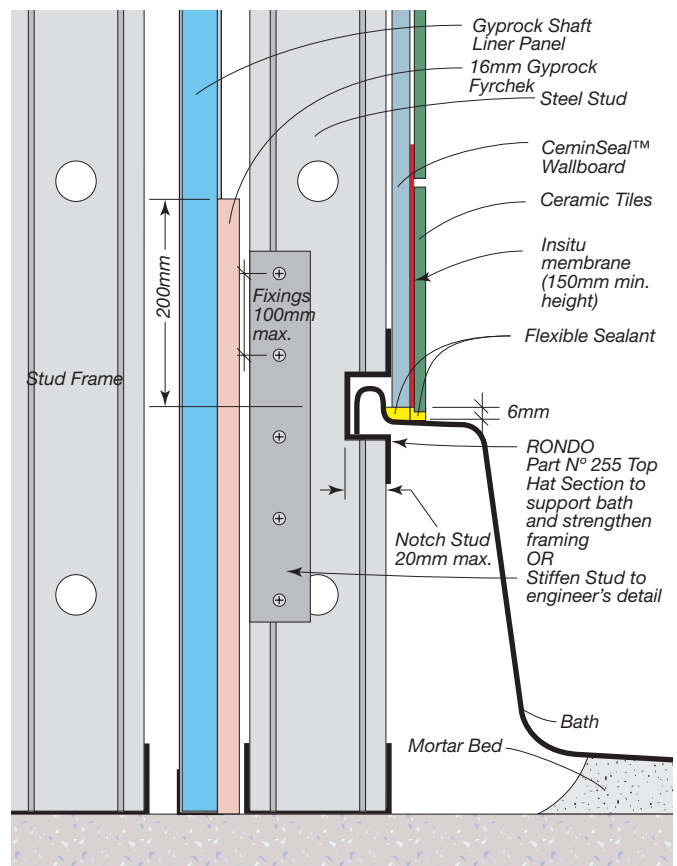

Figure 21: Fixing Of Wall Clip to Timber Stud Framing And H-stud

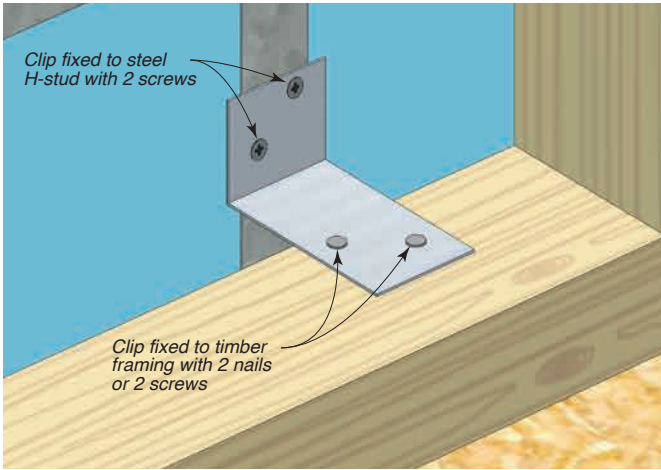

Figure 22: Fixing Of Wall Clip to Steel Stud Framing And H-stud

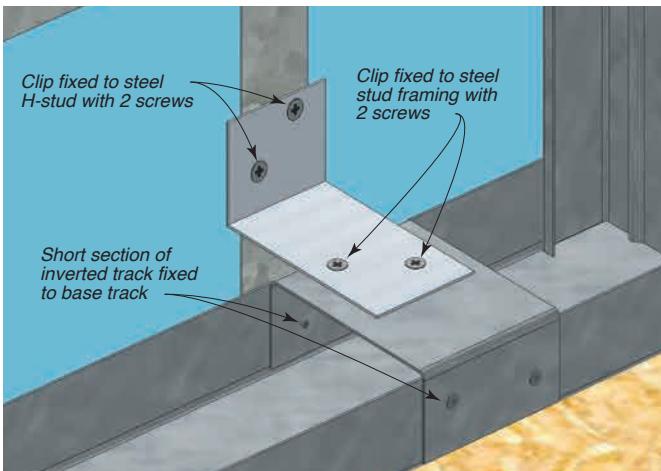

Figure 23: Fixing Aluminium Straps At End Of Wall

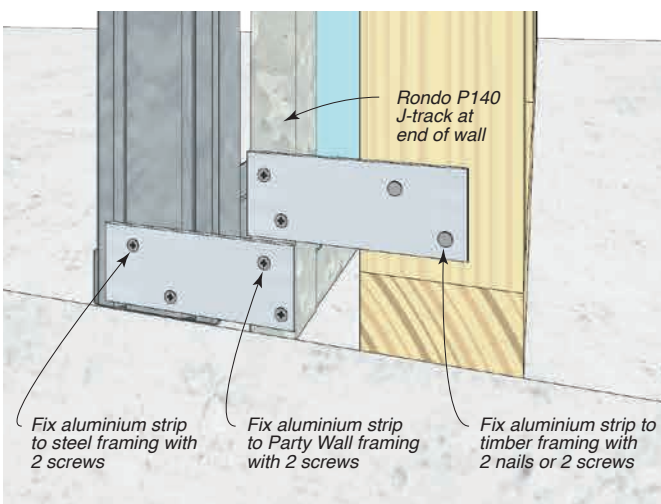

Figure 24: Junction Of Party Wall And Non-Fire Rated Internal Timber Framed Wall – Plan View

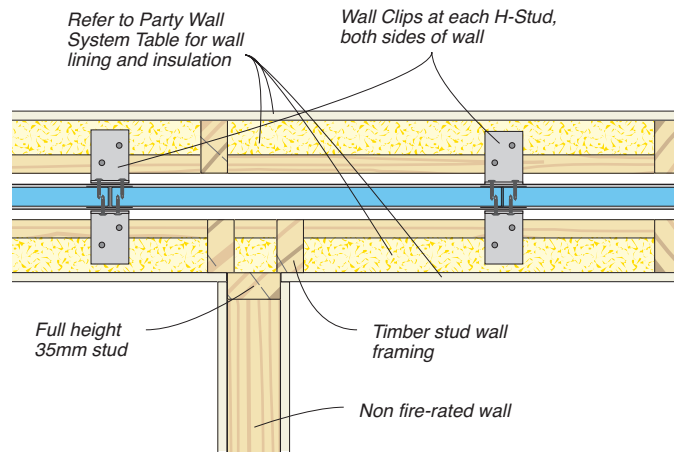

Figure 25: Junction Of Party Wall And Non-Fire Rated Internal Steel Framed Wall – Plan View

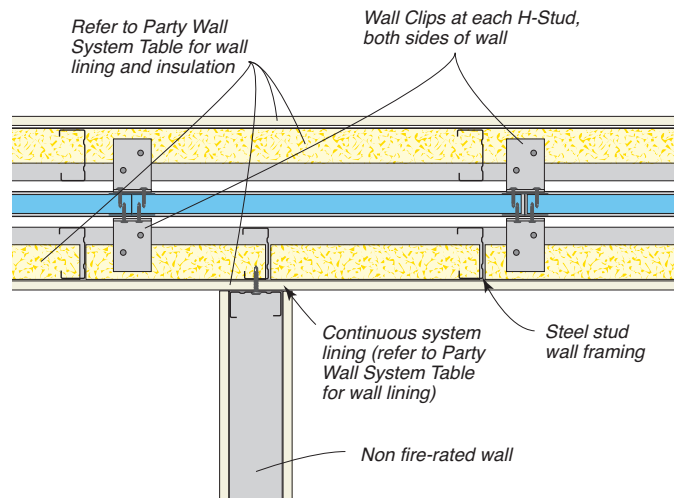

Figure 26: Junction Of Party Wall And Non-Fire Rated Internal Steel Framed Wall – Alternative Method – Plan View

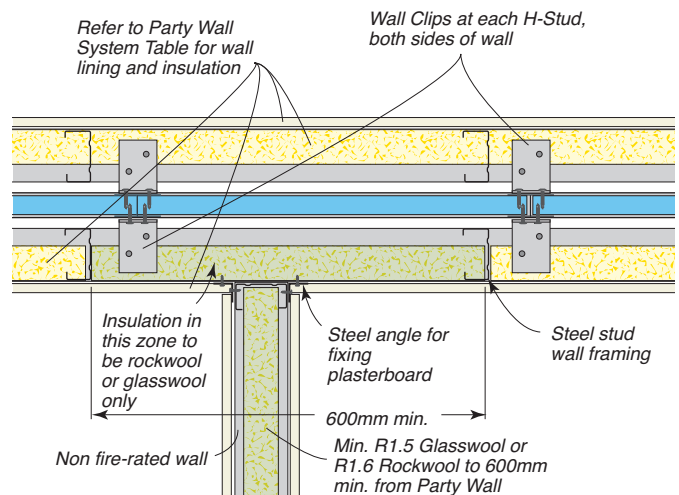

Figure 27: Junction Of Party Wall And Party Wall At Corner (clip on external side) – Plan View

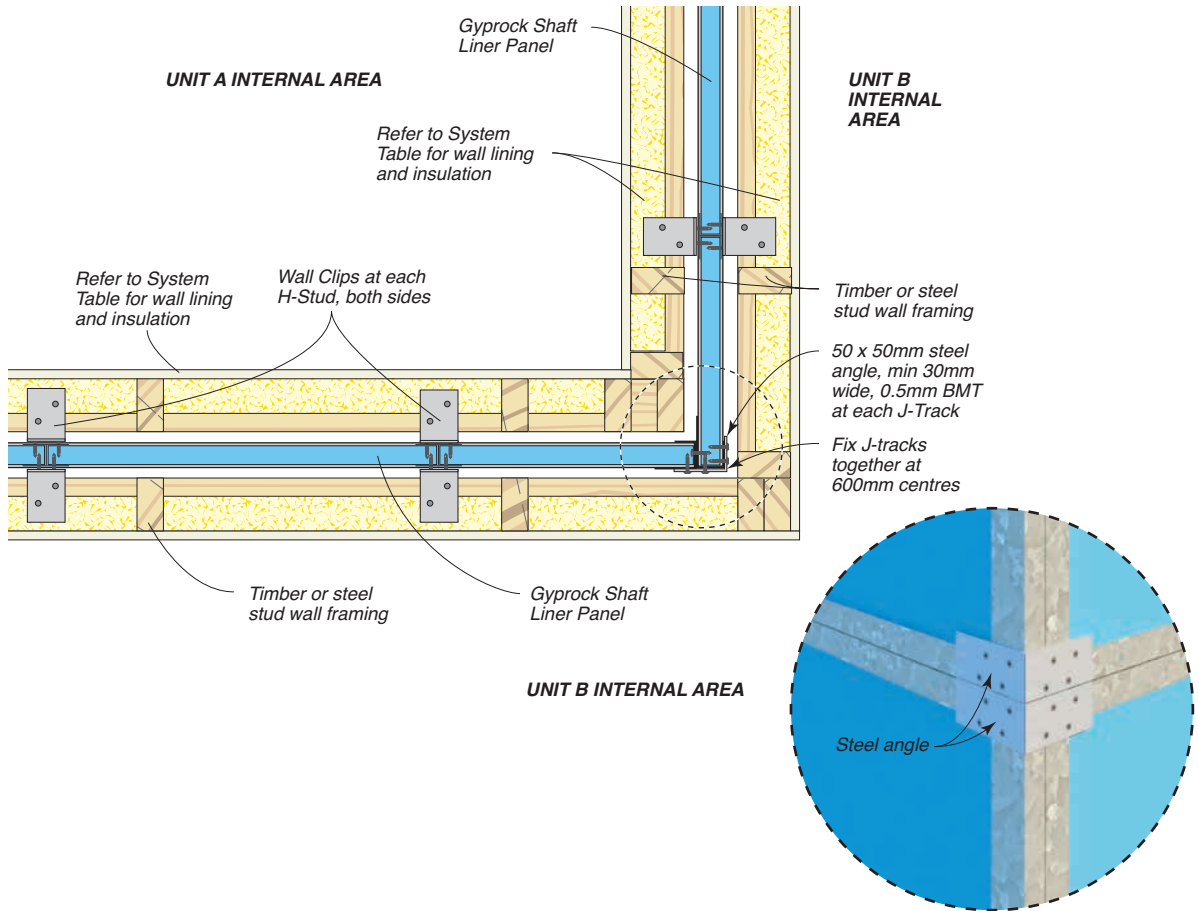

Figure 28: Junction Of Party Wall And Party Wall At Corner (clip on internal side)– Plan View

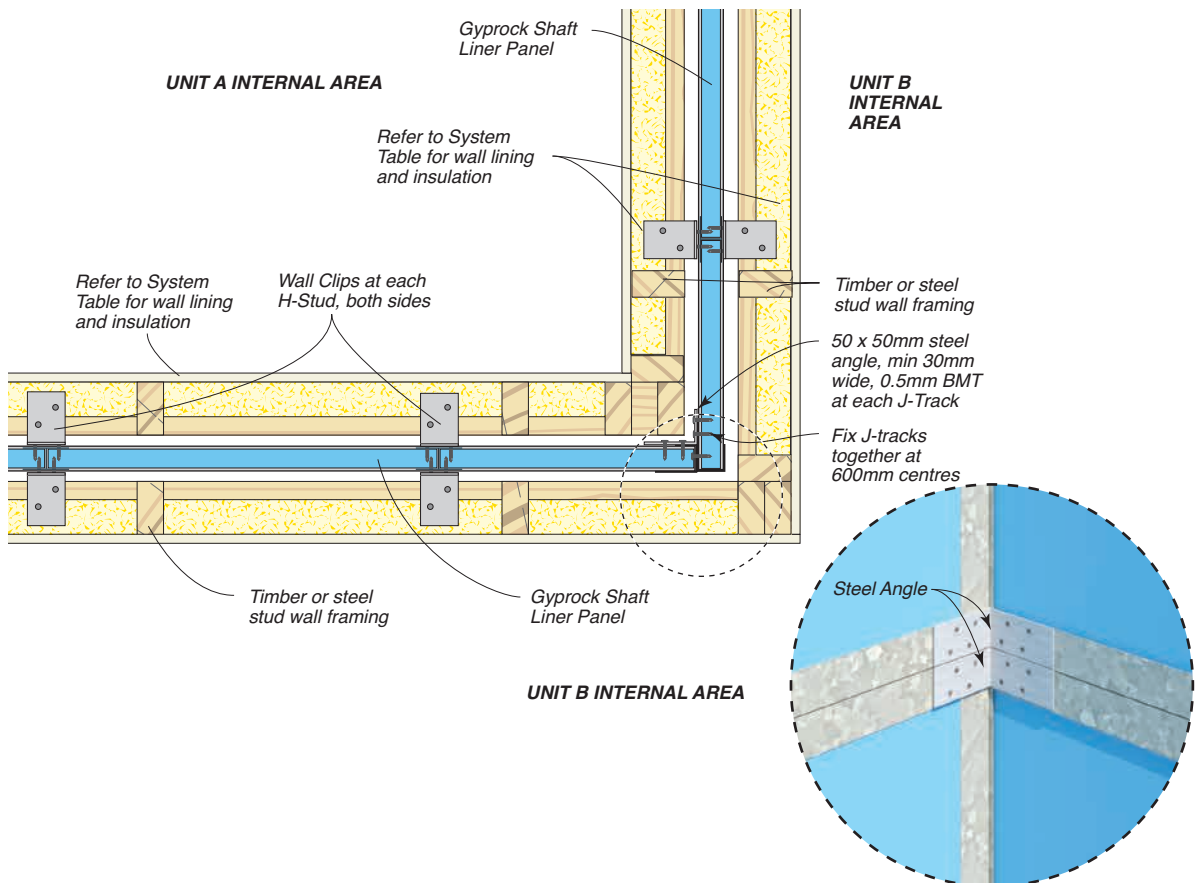

Figure 29: Junction Of Party Wall to Party Wall at T-Intersection (Option 1) – Plan View

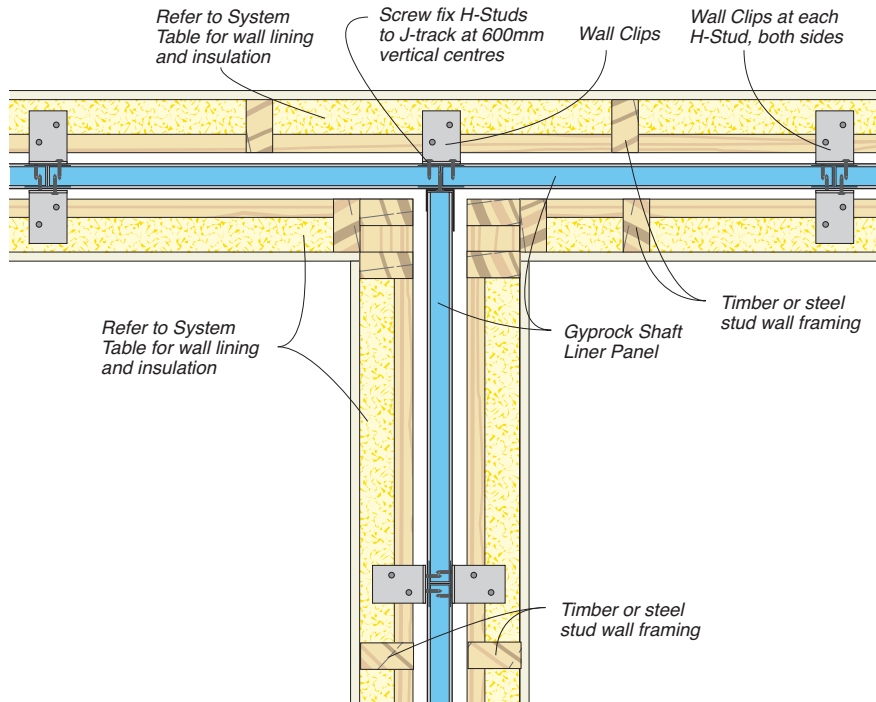

Figure 30: Junction Of Party Wall to Party Wall at T-Intersection (Option 2) – Plan View

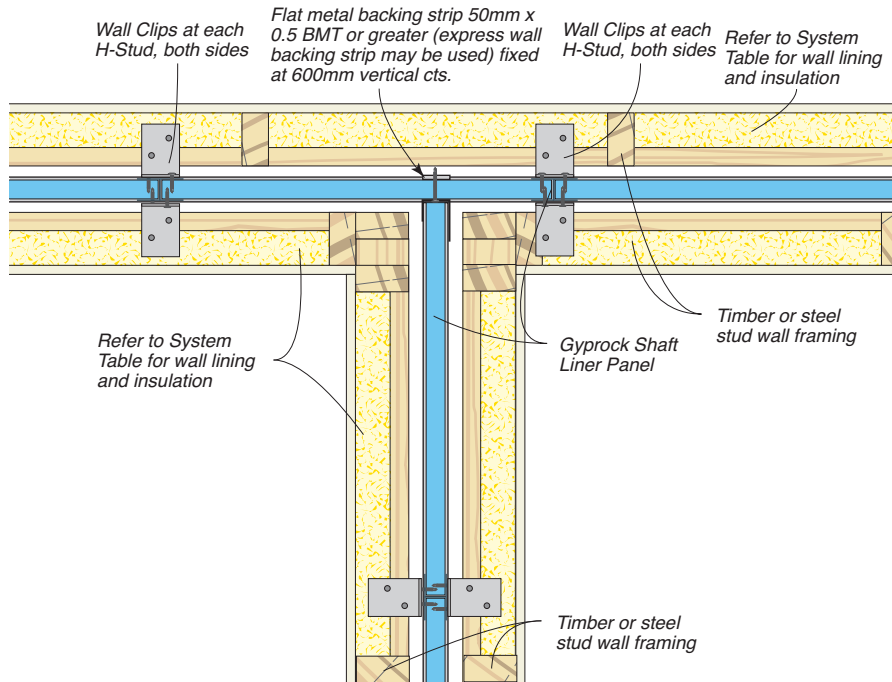

Figure 31: Fixing Method 1

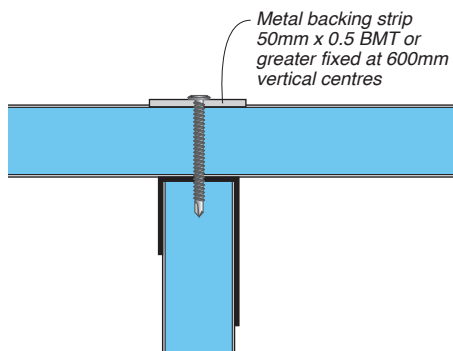

Figure 32: Fixing Method 2

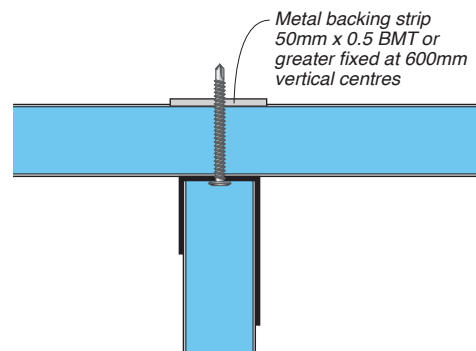

Figure 33: Junction Party Wall To Party Wall At 4-Way Intersection – Plan View

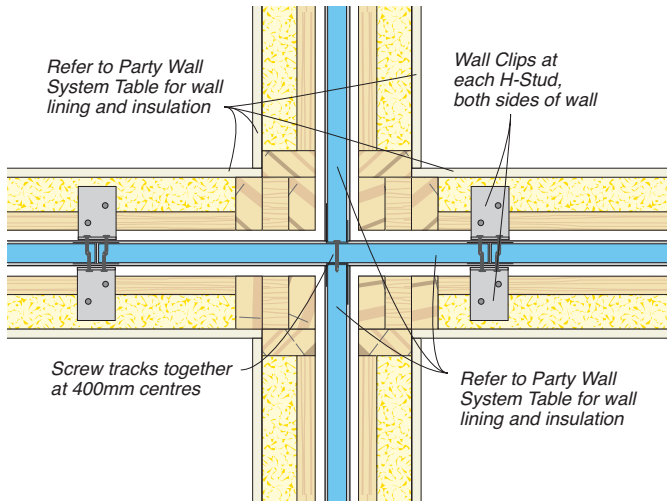

Figure 34: Installation Of Fyrcek Plasterboard Lamination (Option 1)

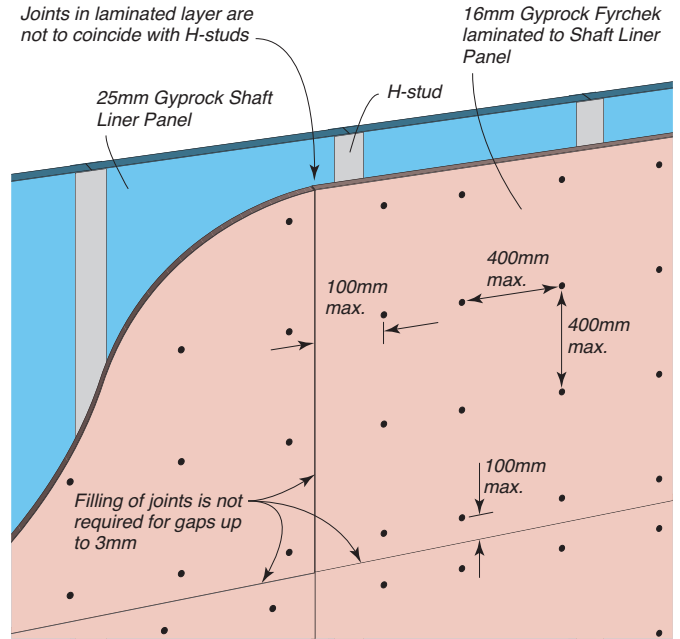

Figure 35: Installation Of Fyrcek Plasterboard Lamination (Option 2)

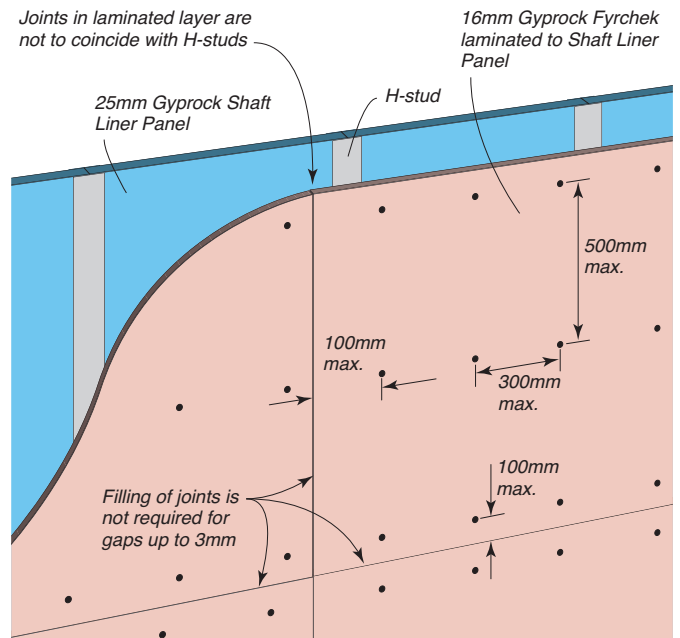

Figure 36: Detail At Upper Storey Framed Floor

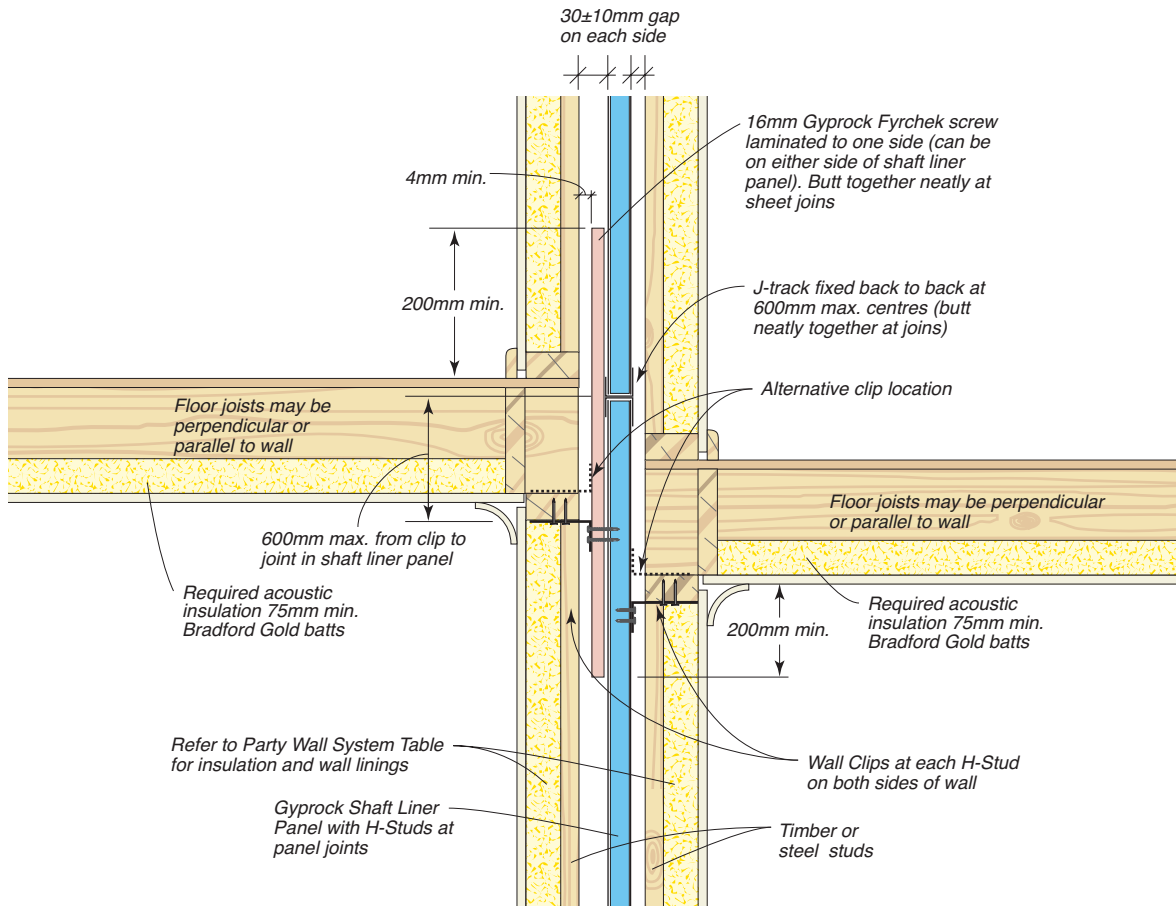

Figure 37: Detail For Steel Column And Beam Support

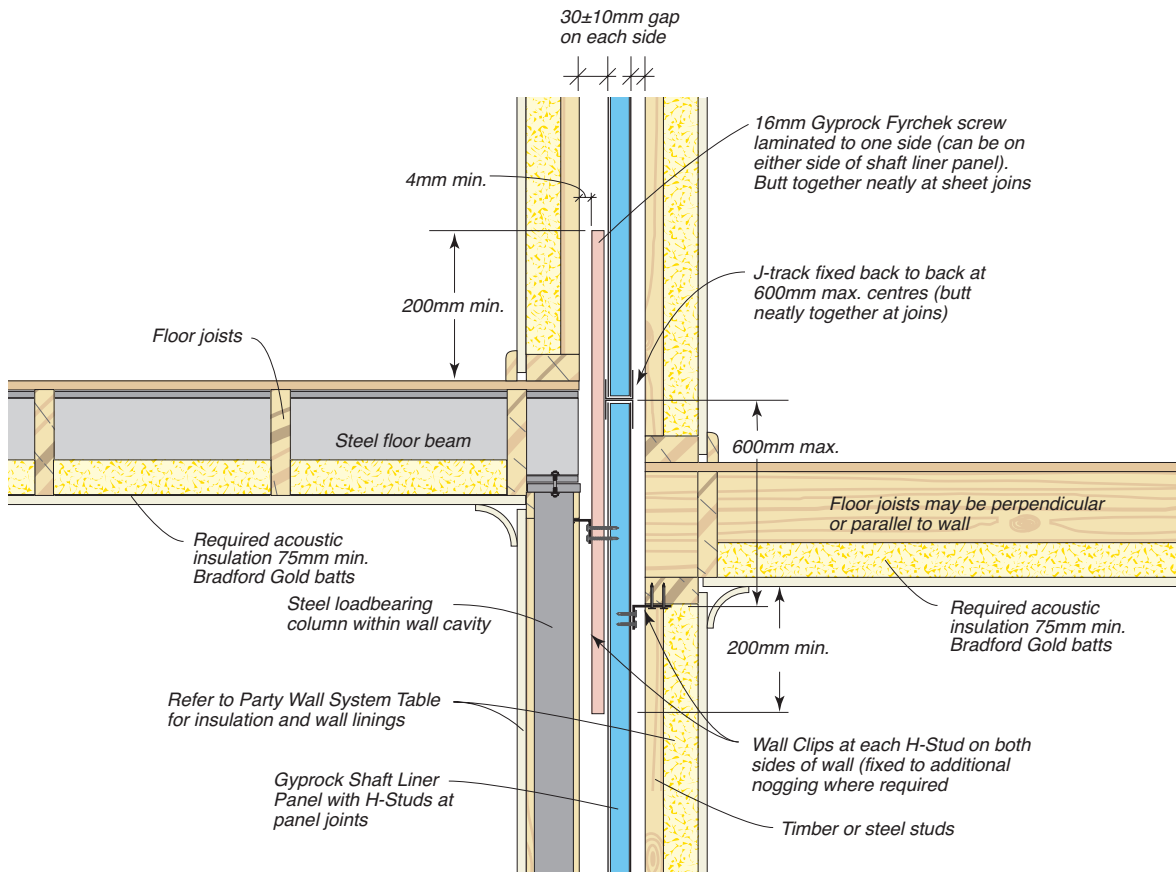

Figure 38: Detail At Roof/Ceiling At Transition From Single To Two Storey

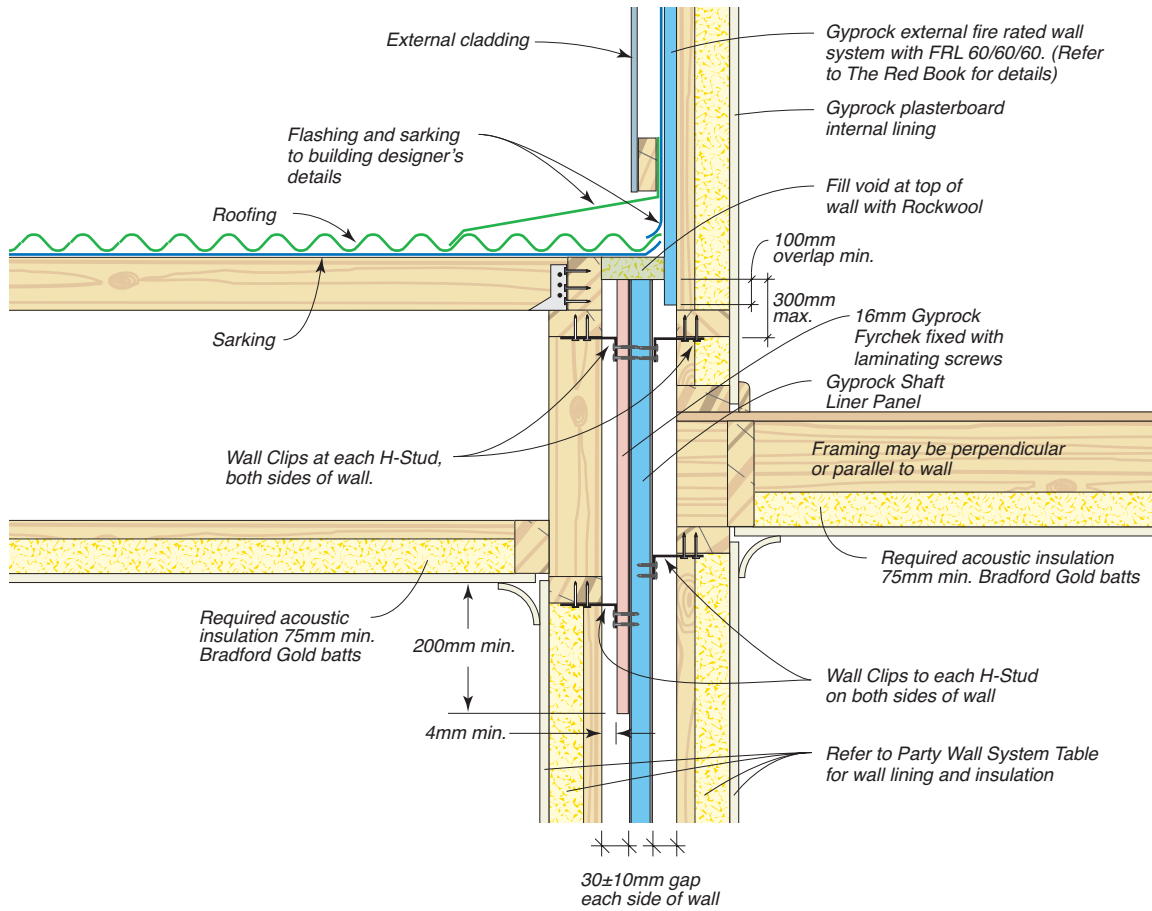

Figure 39: Detail At Roof/Ceiling At Transition From Single To Two Storey

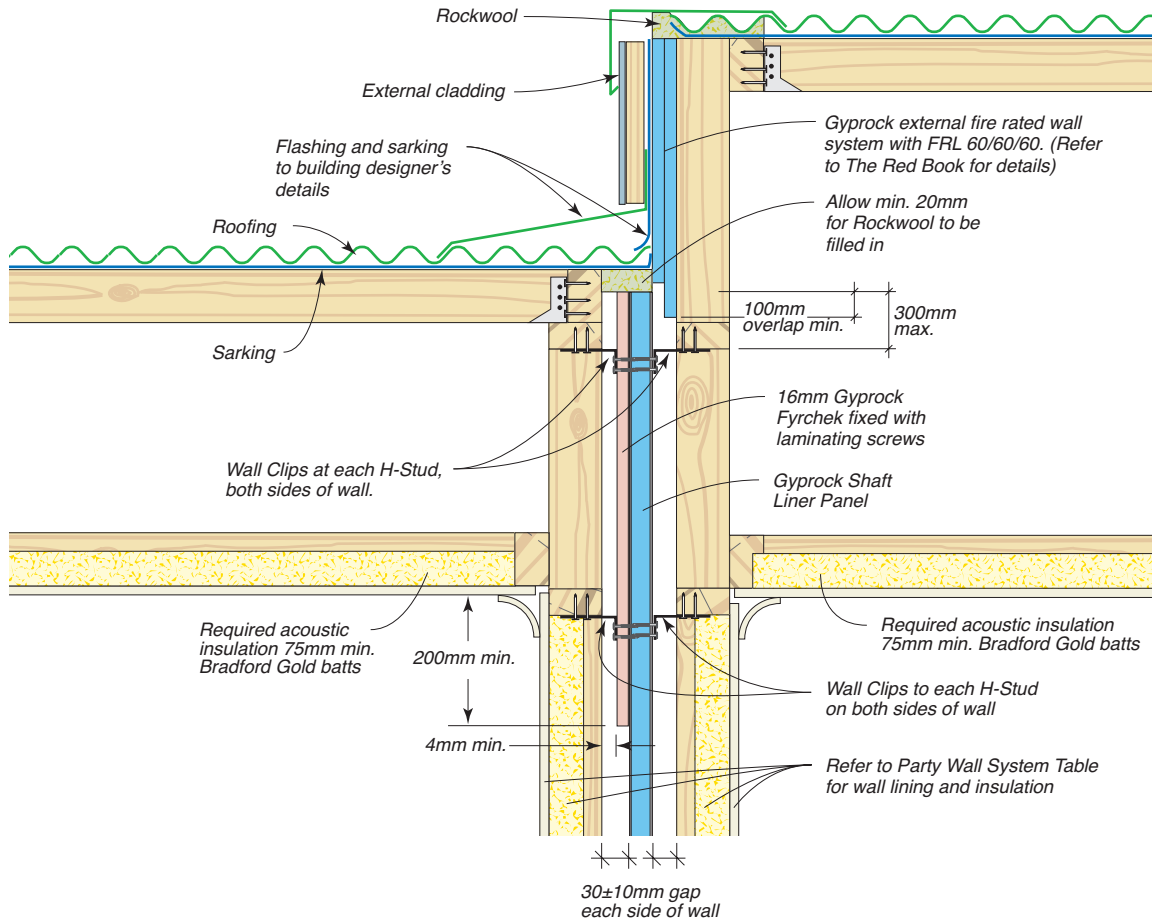

Figure 40: Detail At Ceiling And Roof

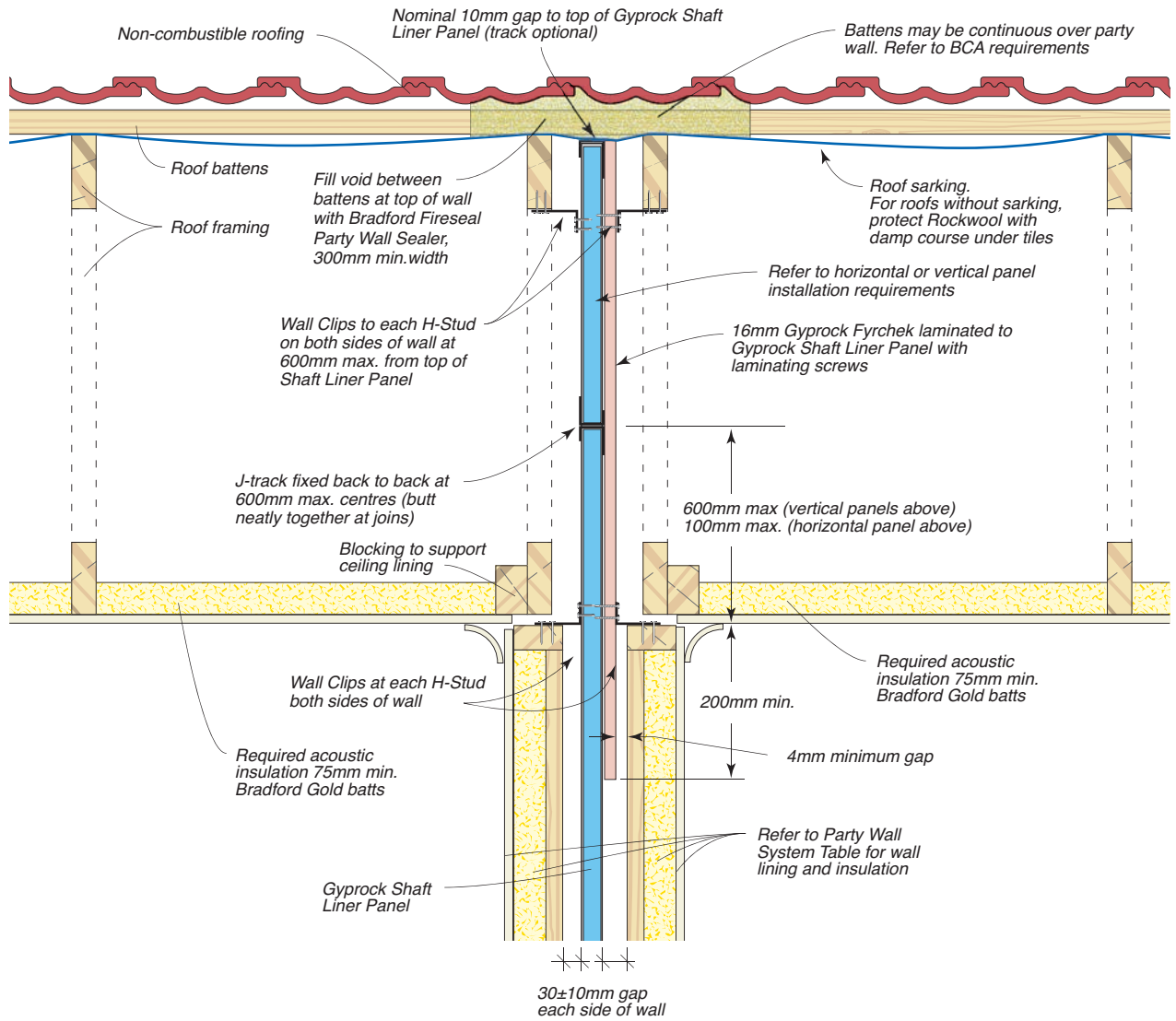

Figure 41: Detail At Roof/Ceiling And Valley Gutter

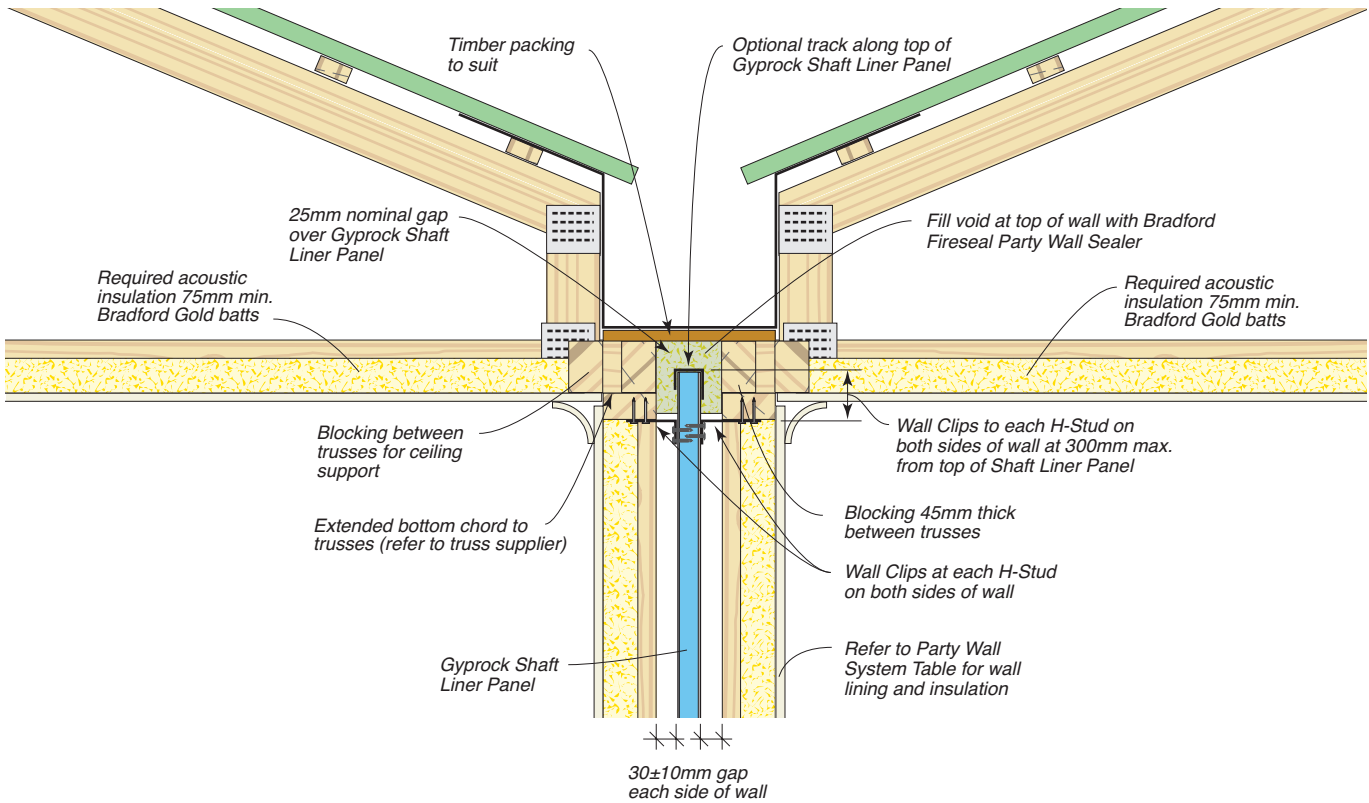

Figure 42: Detail At Roof/Ceiling And Parapet

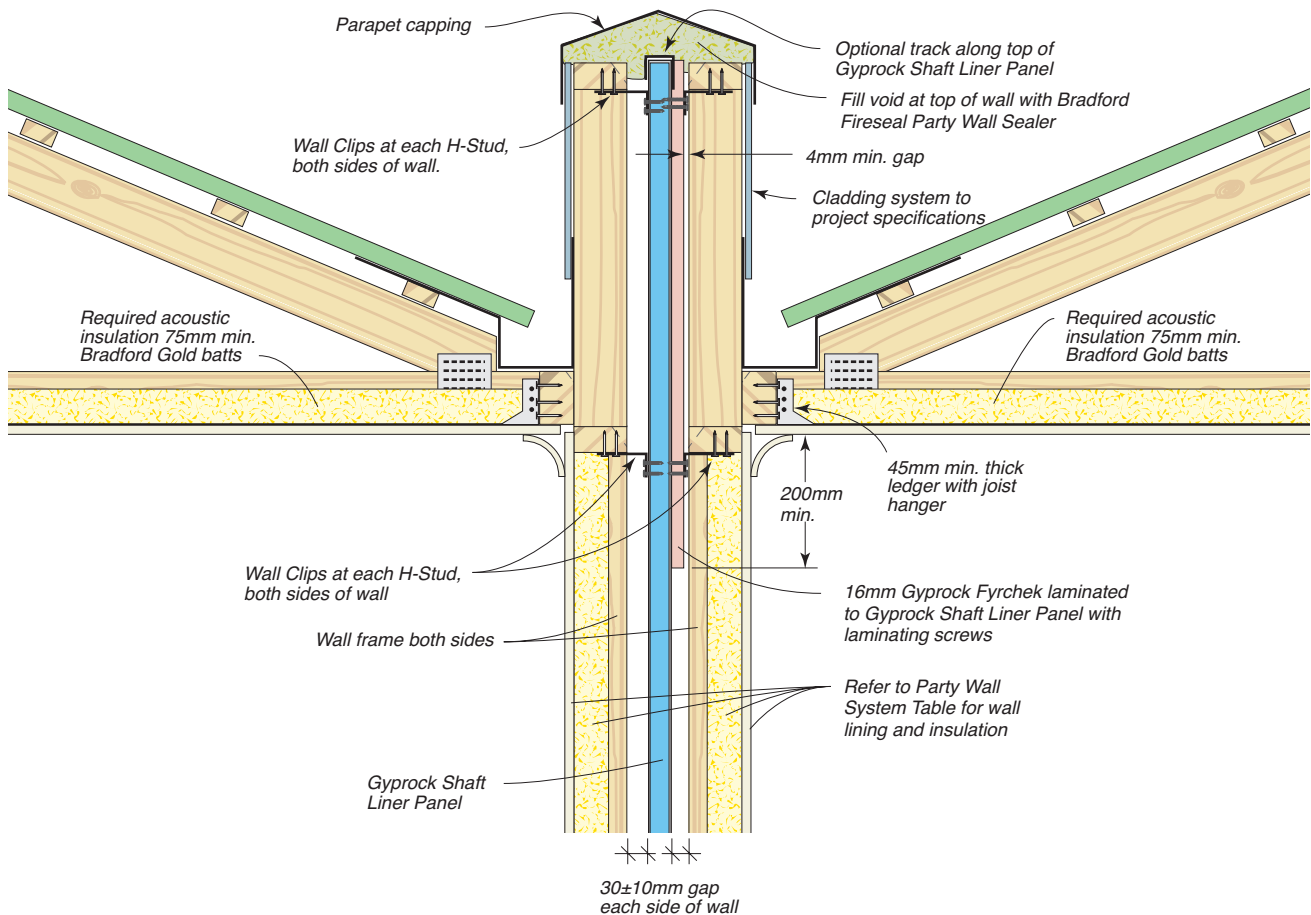

Figure 43: Detail At Roof/Ceiling With Continuous Roofing Over Party Wall

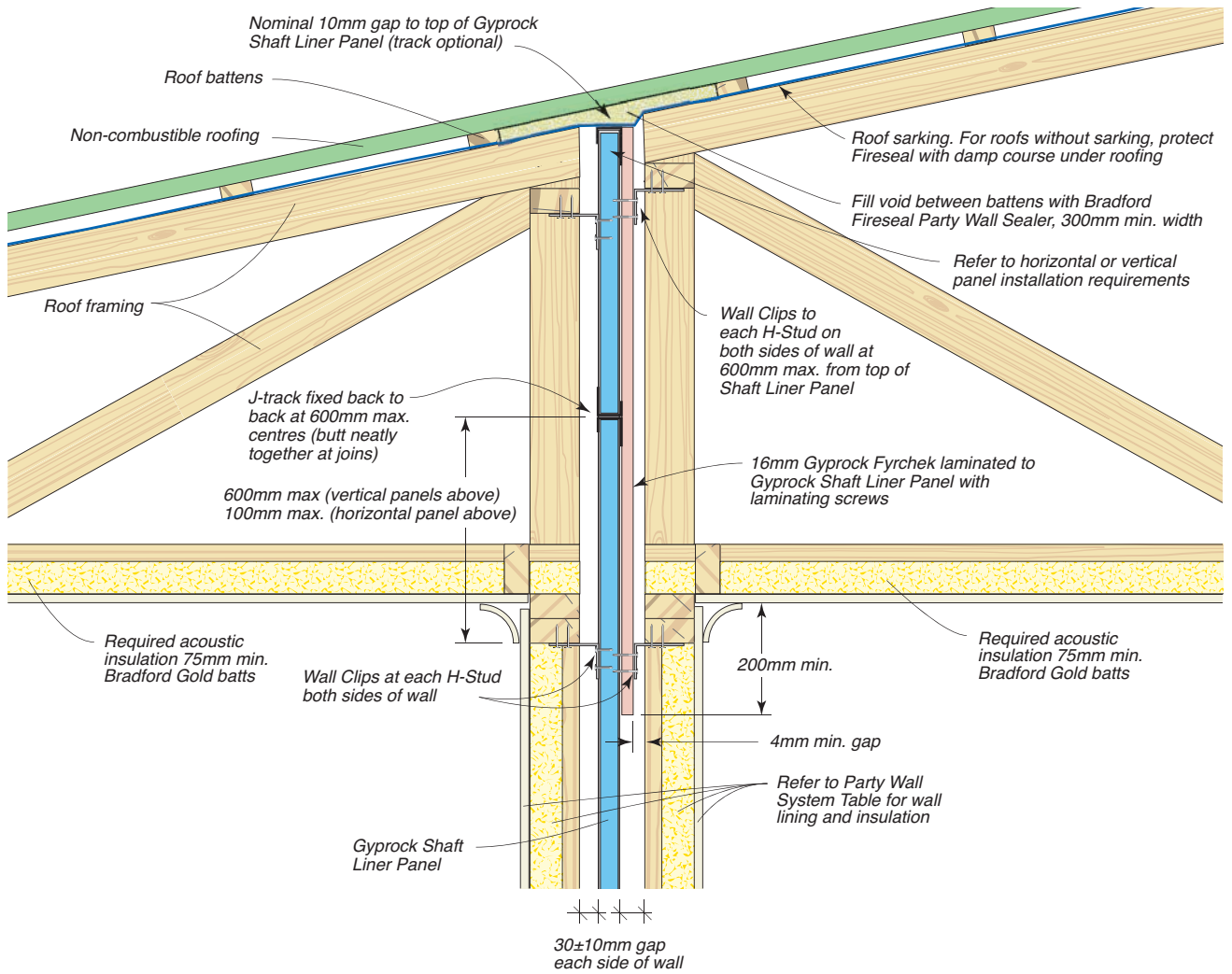

Figure 44: Detail At Stepped Roof/Ceiling

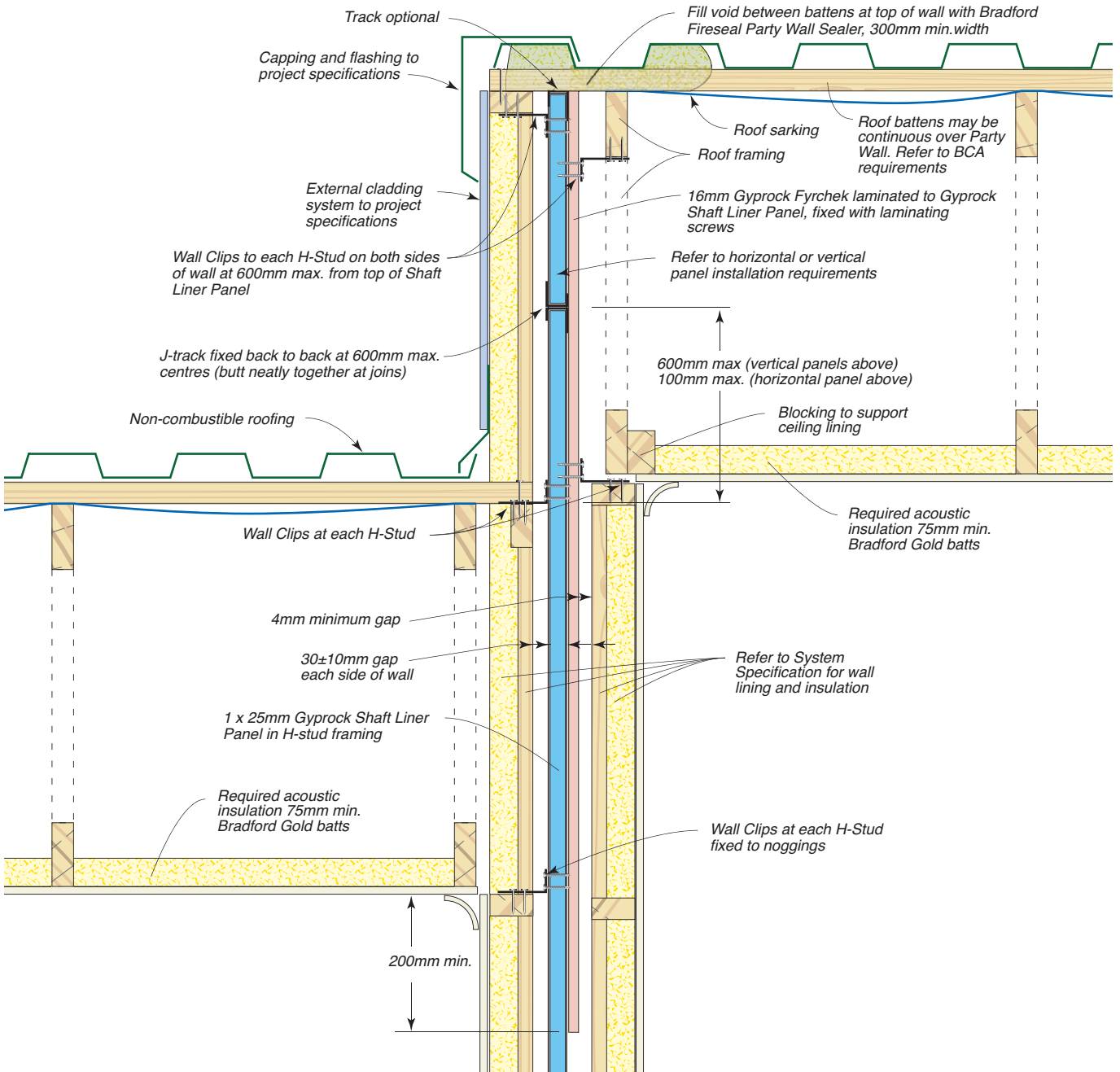

Figure 45: Roof With Party Wall To Underside Of Lower Roof Line

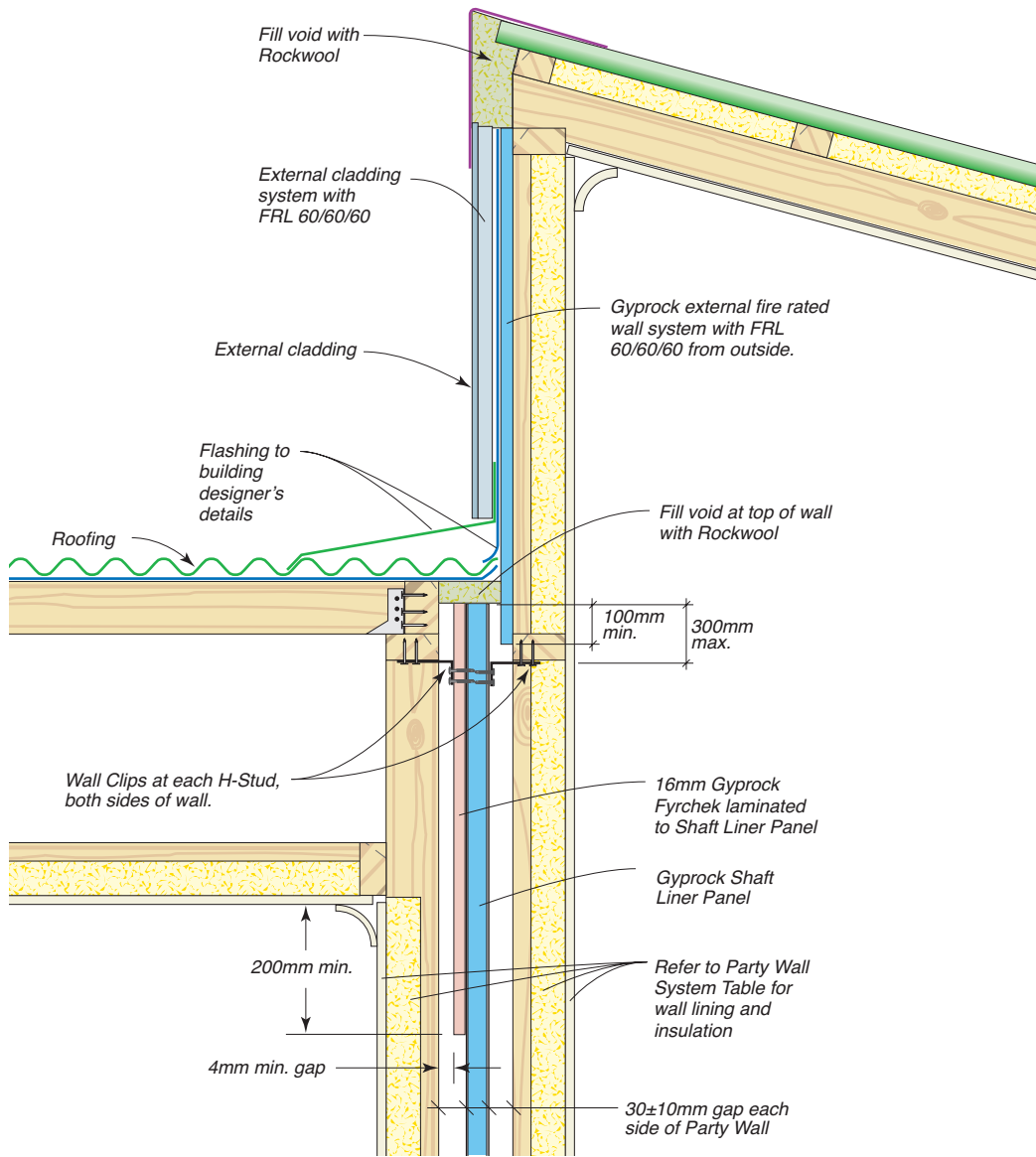

Figure 46: Roof Void With Horizontal & Vertical Panels – Party Wall Parallel to Truss/Rafter (Front Elevation)

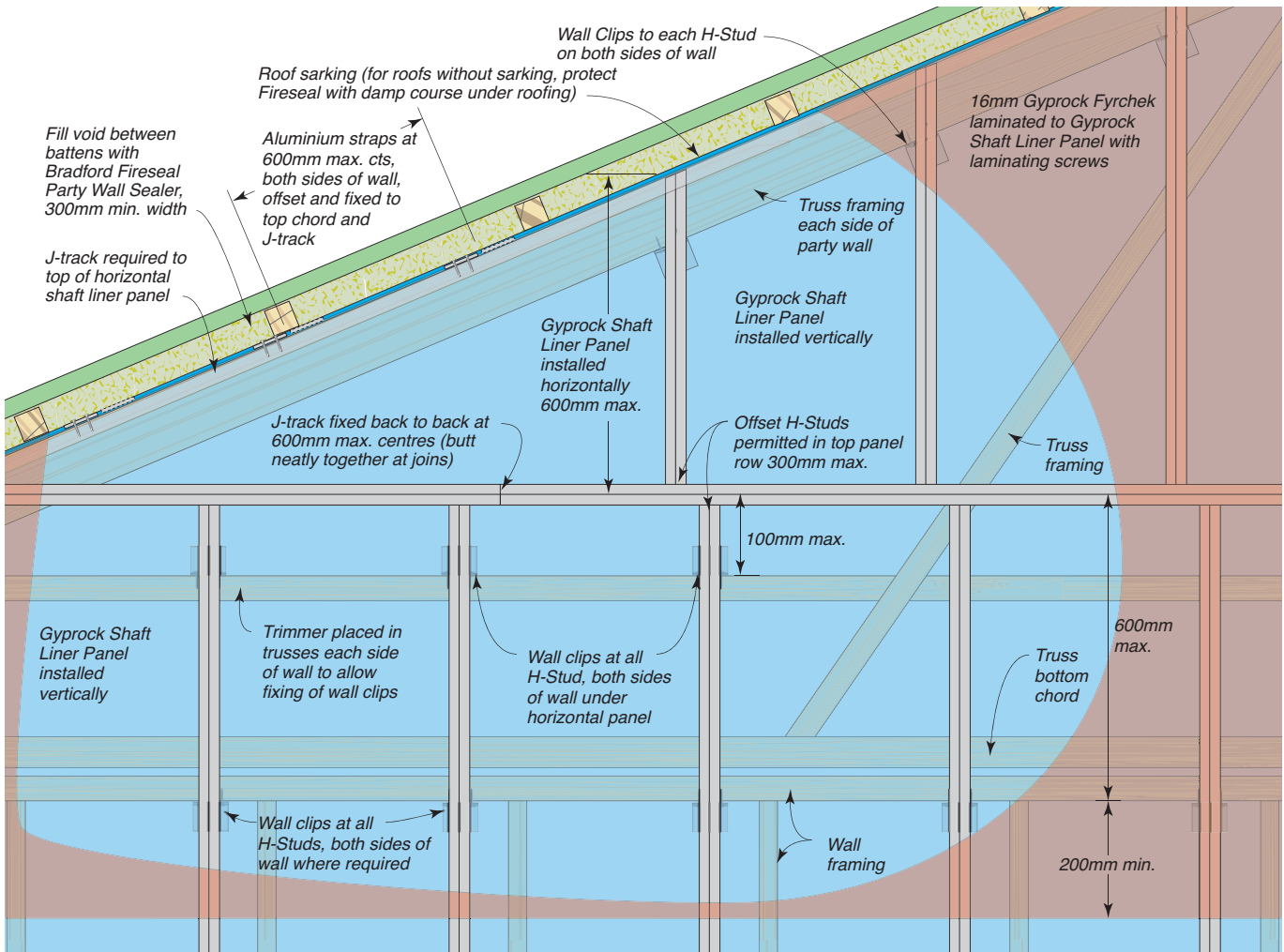

Figure 47: Roof Void With Horizontal & Vertical Panels – Party Wall Parallel to Truss/Rafter (Side Elevation)

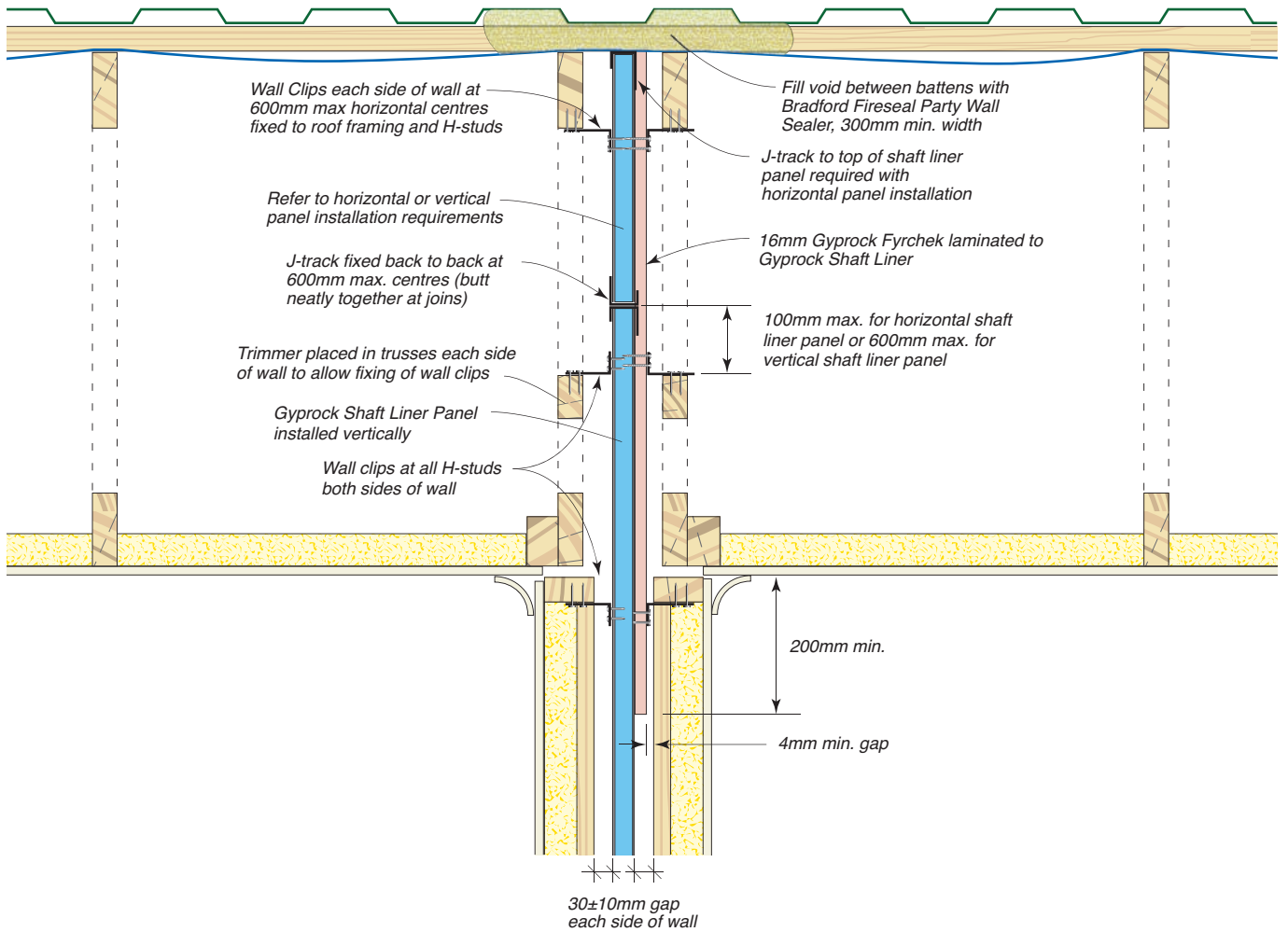

Figure 48: Roof Void With Horizontal Over Vertical Panels – Party Wall Perpendicular to Truss/Rafter (Front Elevation)

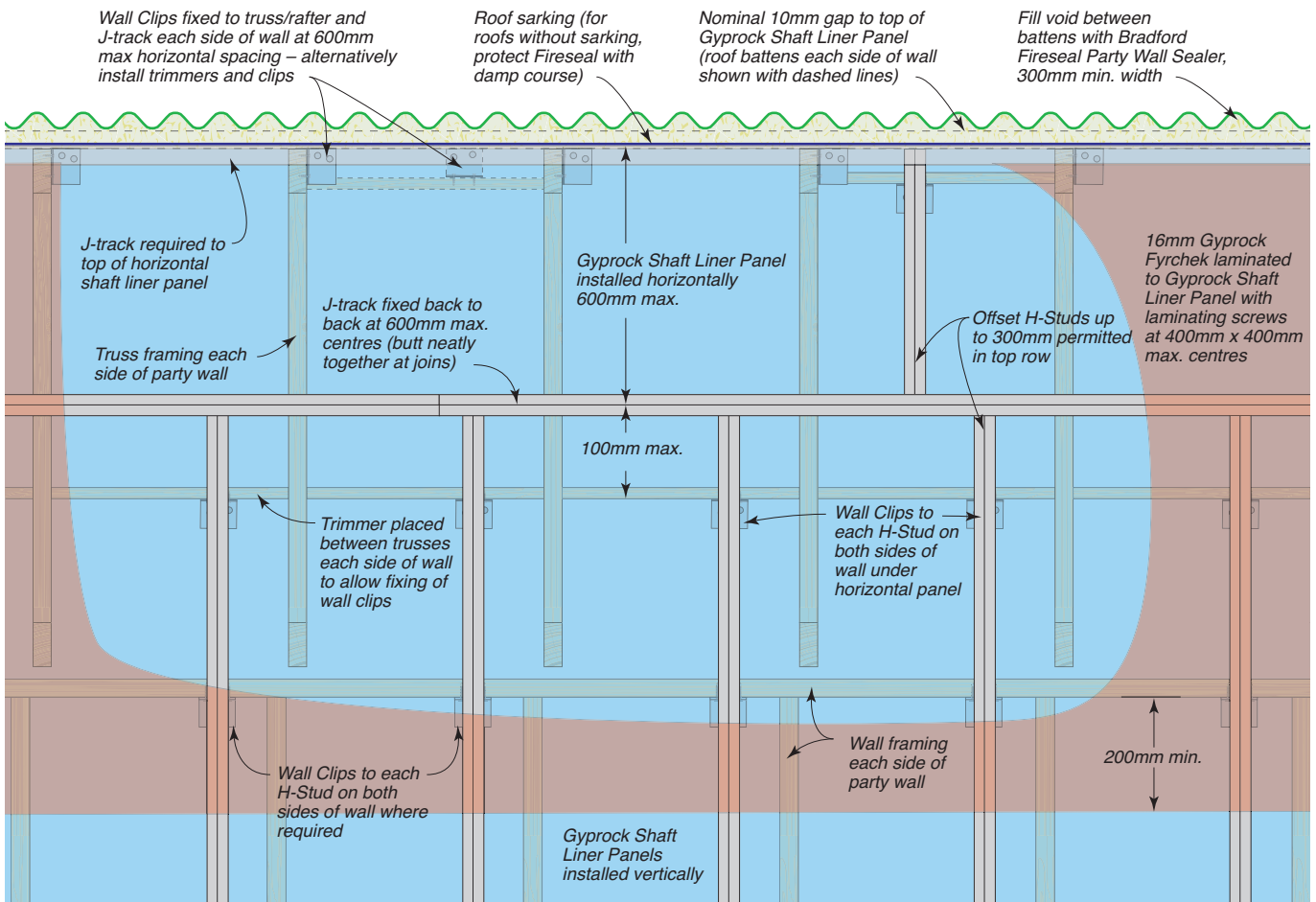

Figure 49: Floor step down with vertical shaft liner panels – (Front Elevation)

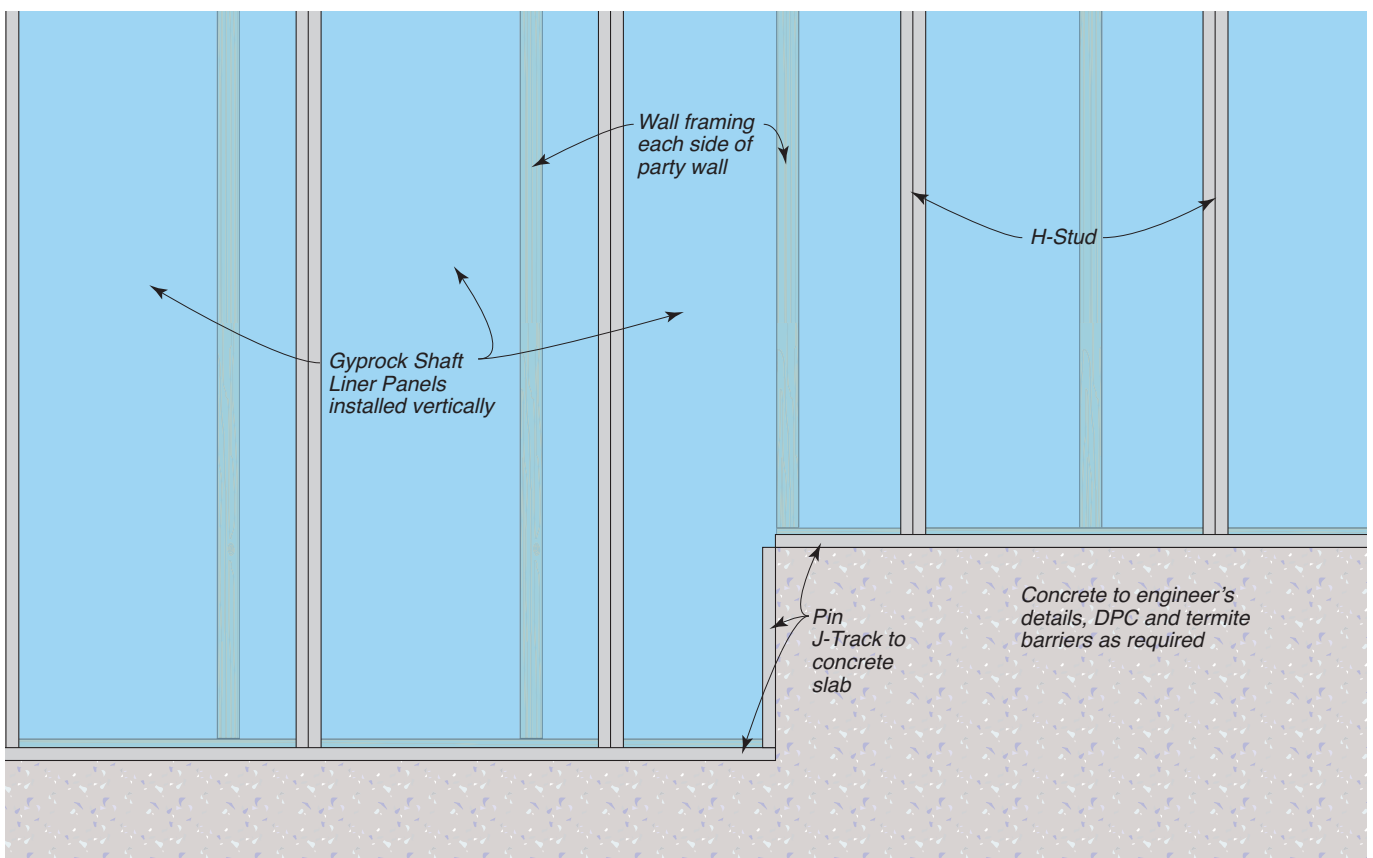

Figure 50: Roof Void With Horizontal Over Vertical Panels – Party Wall Perpendicular to Truss/Rafter (Side Elevation)

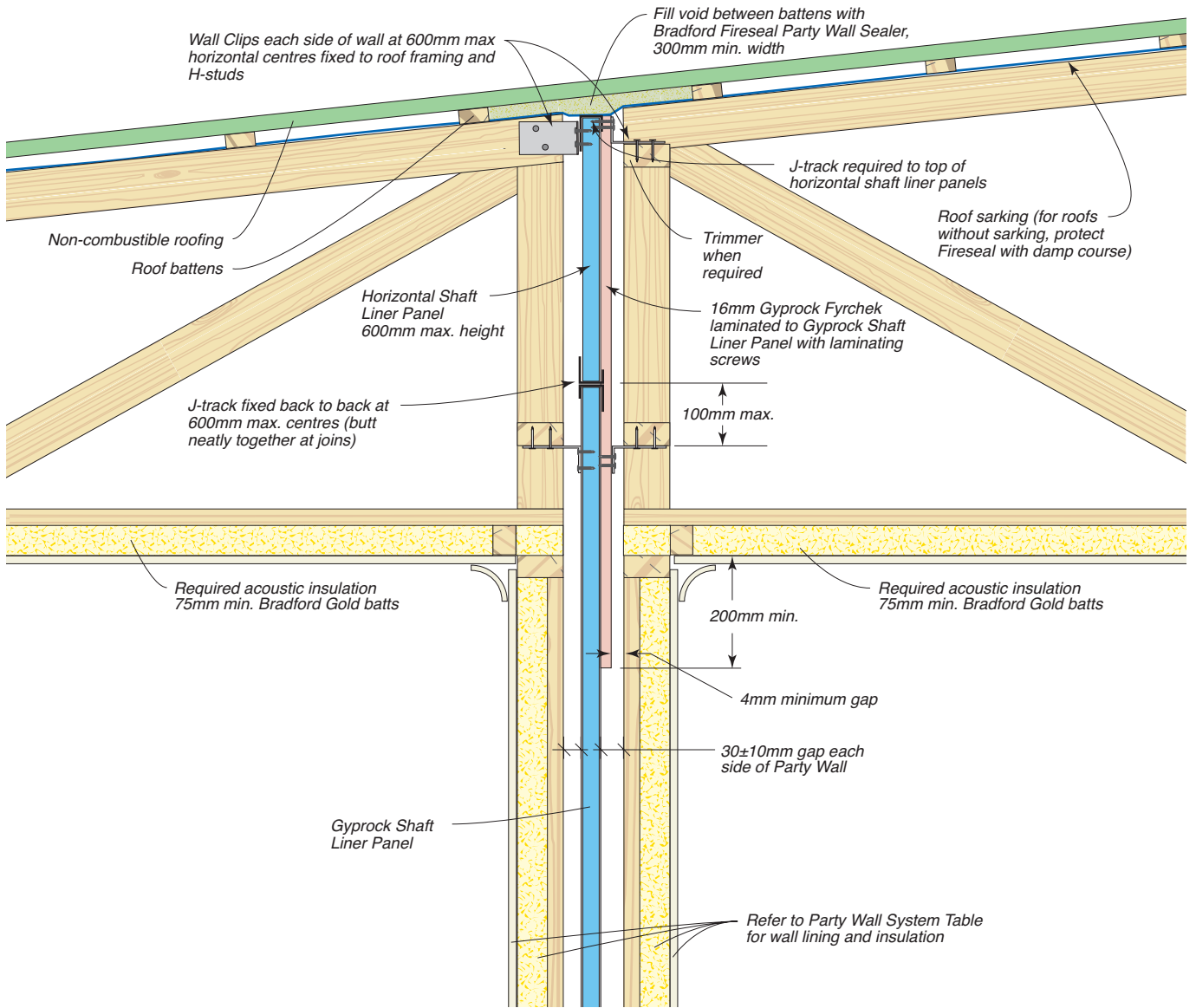

Figure 51: Eaves Detail Fascia – Front Elevation – Appraisal: Refer to BCA

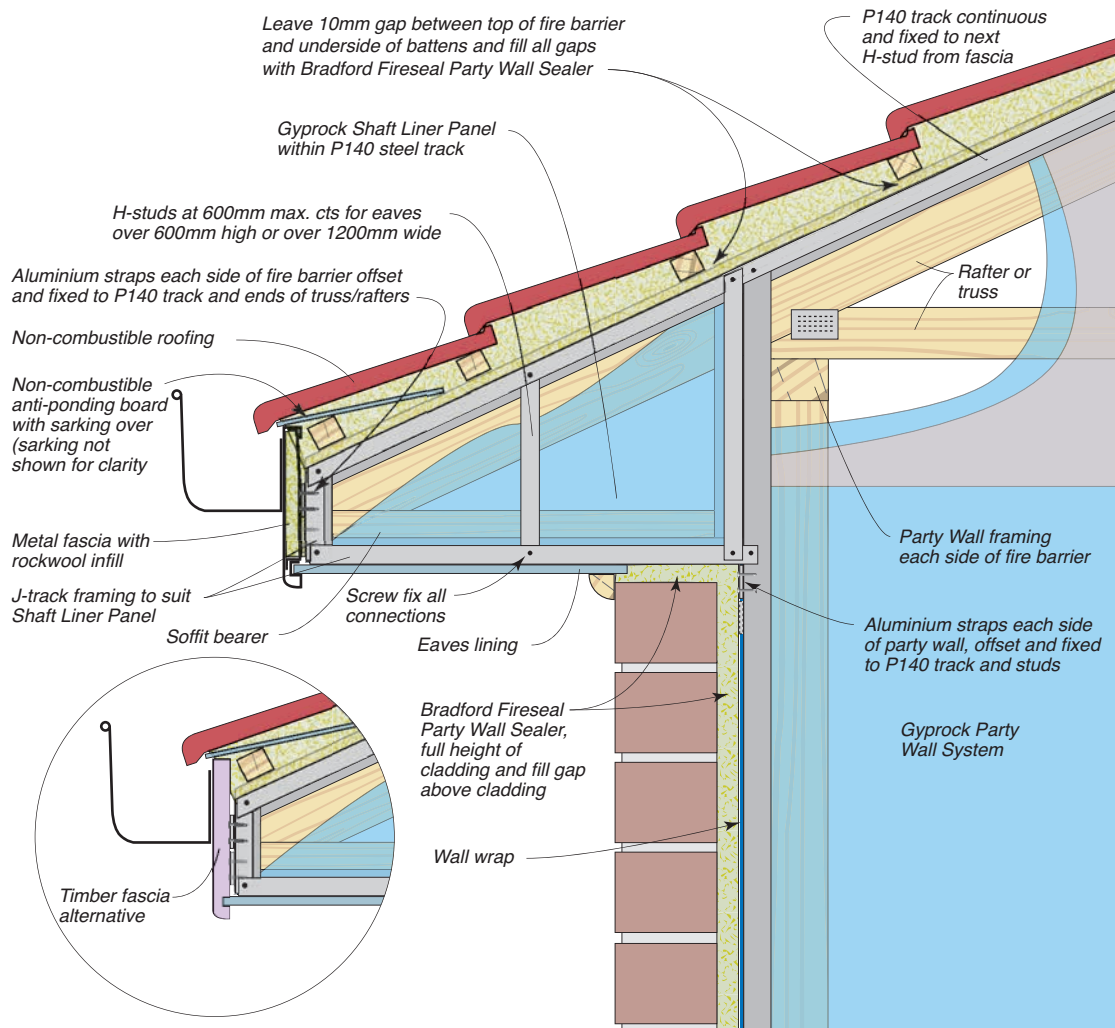

Figure 52: Eaves Detail – Outside End Elevation – Appraisal: Refer to BCA

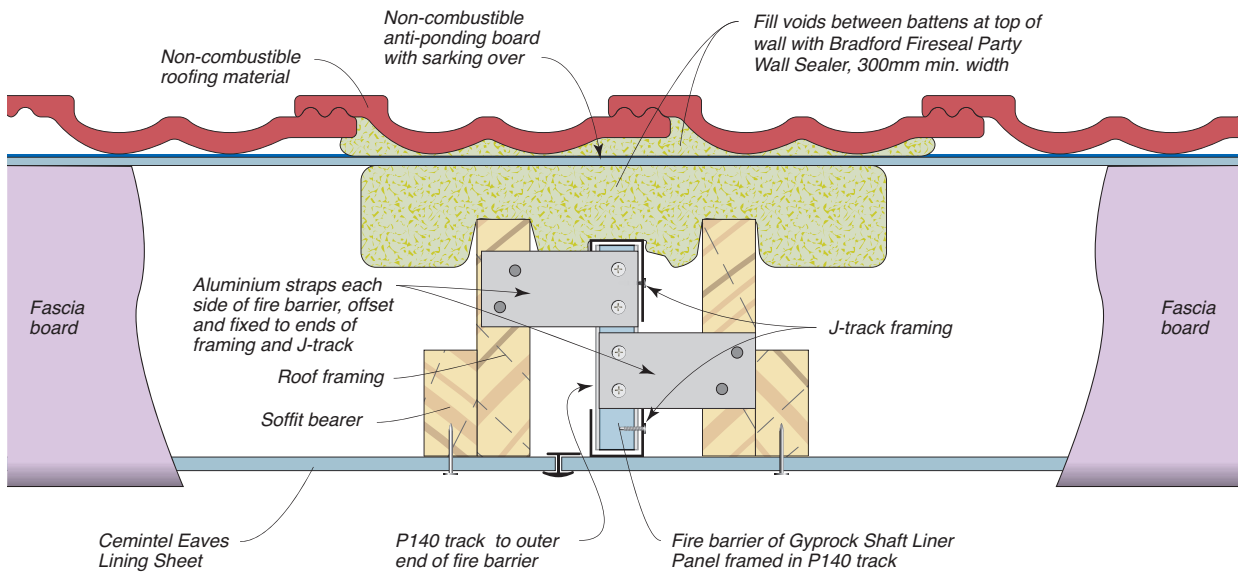

Figure 53: Junction Of Party Wall And External Wall With Lightweight Cladding Direct Fixed to Studs – Plan View

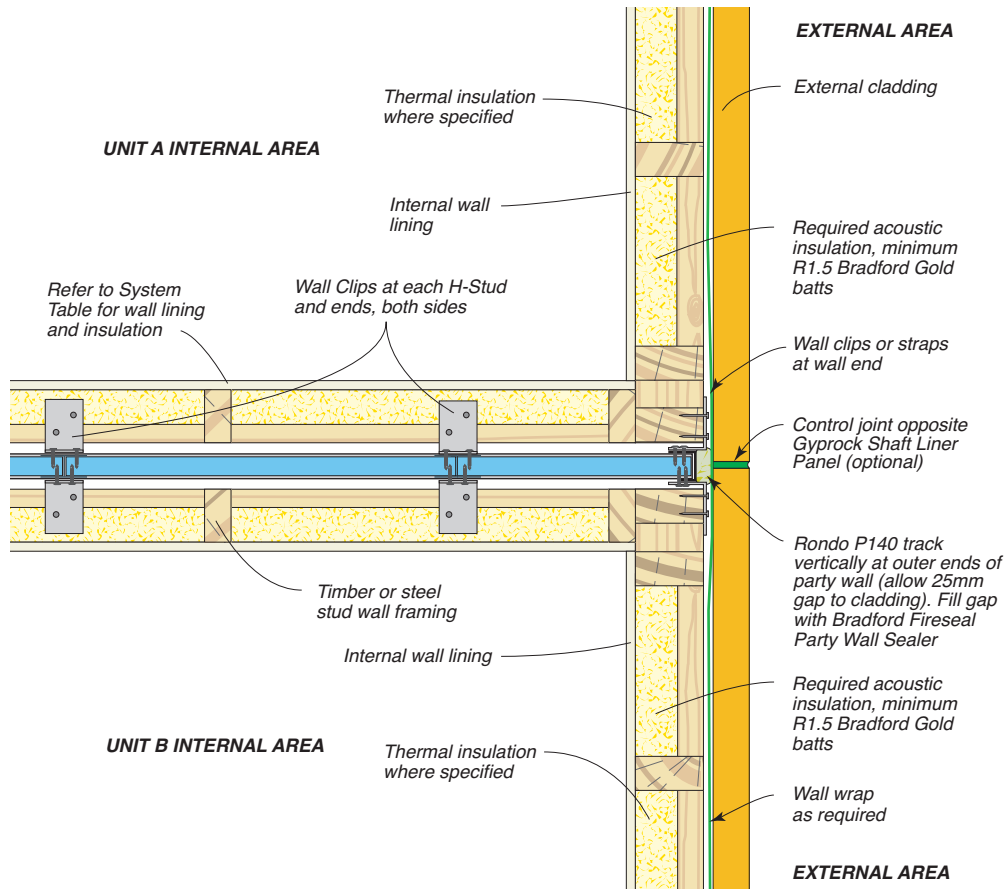

Figure 54: Junction Of Party Wall And External Wall With Lightweight Cladding Direct Fixed to Studs – Plan View

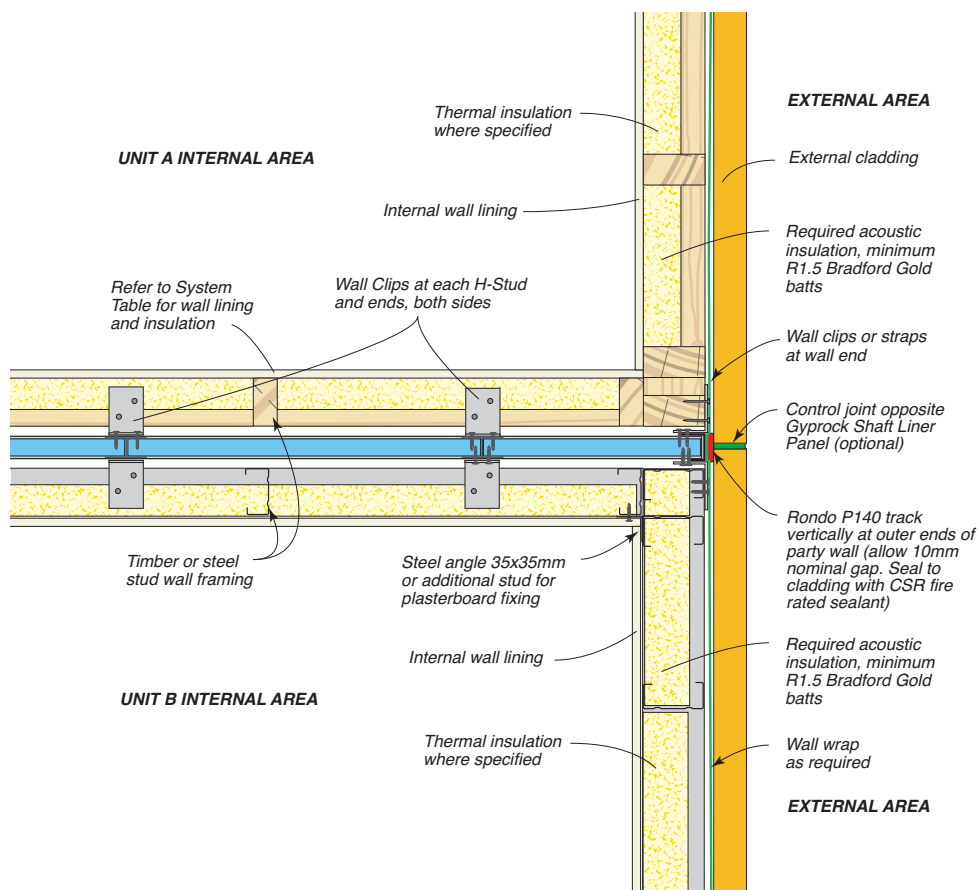

Figure 55: Junction Of Party Wall And External Wall With Cemintel Territory Series Cladding – Plan View

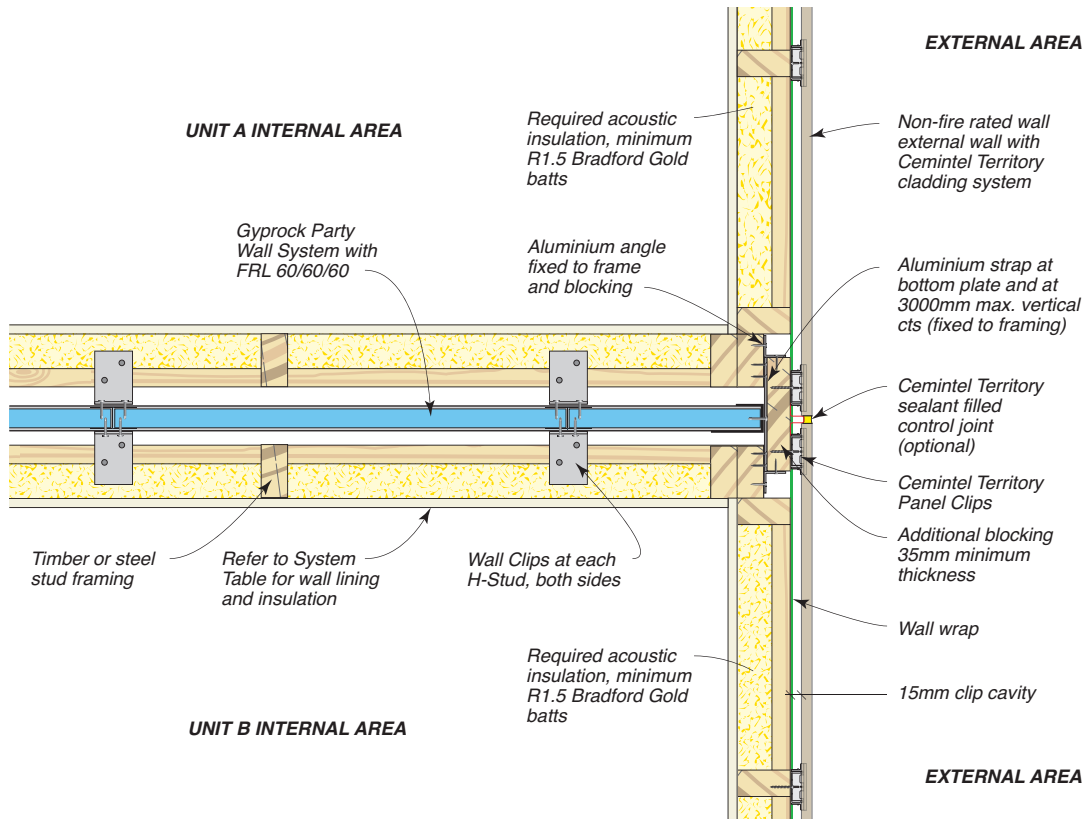

Figure 56: Junction Of Party Wall And External Wall With Hebel AAC Or Steel Sheet Cladding – Plan View

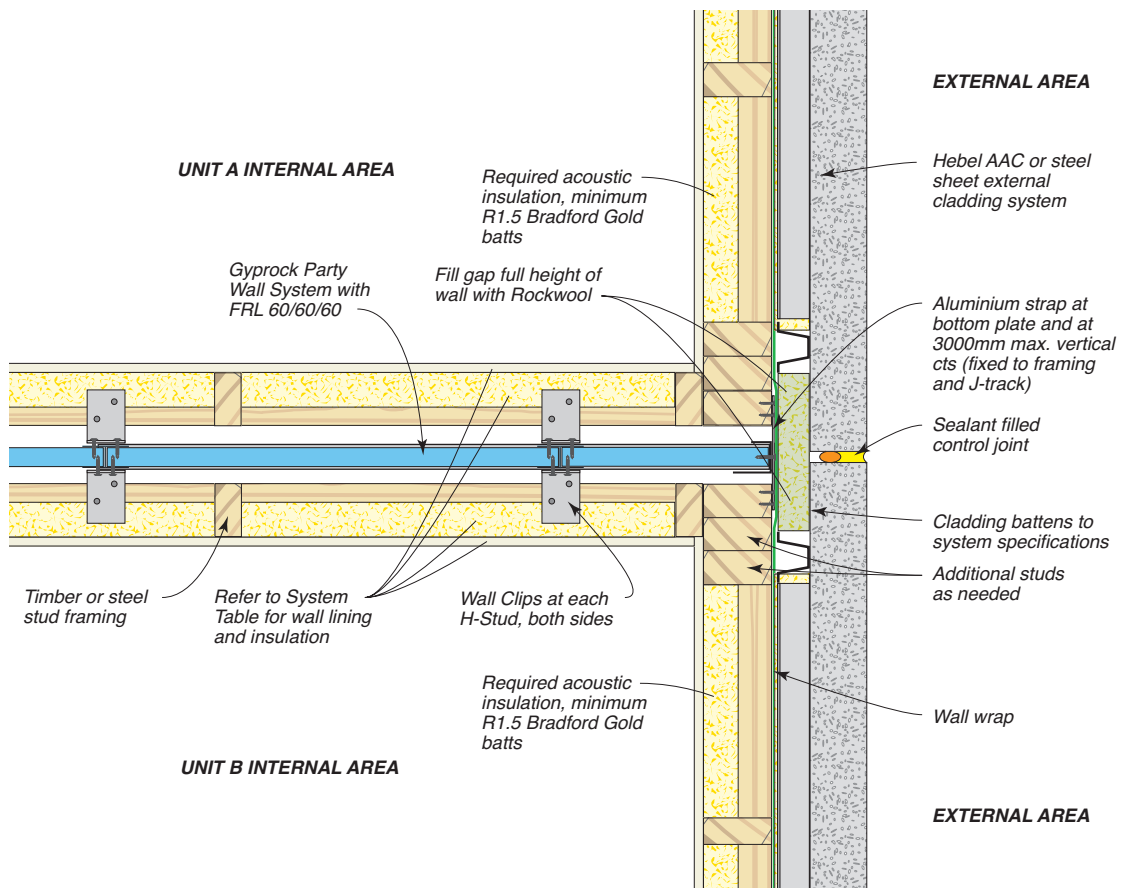

Figure 57: Junction Of Party Wall And External Wall With Fibre Cement Cladding on Battens – Plan View

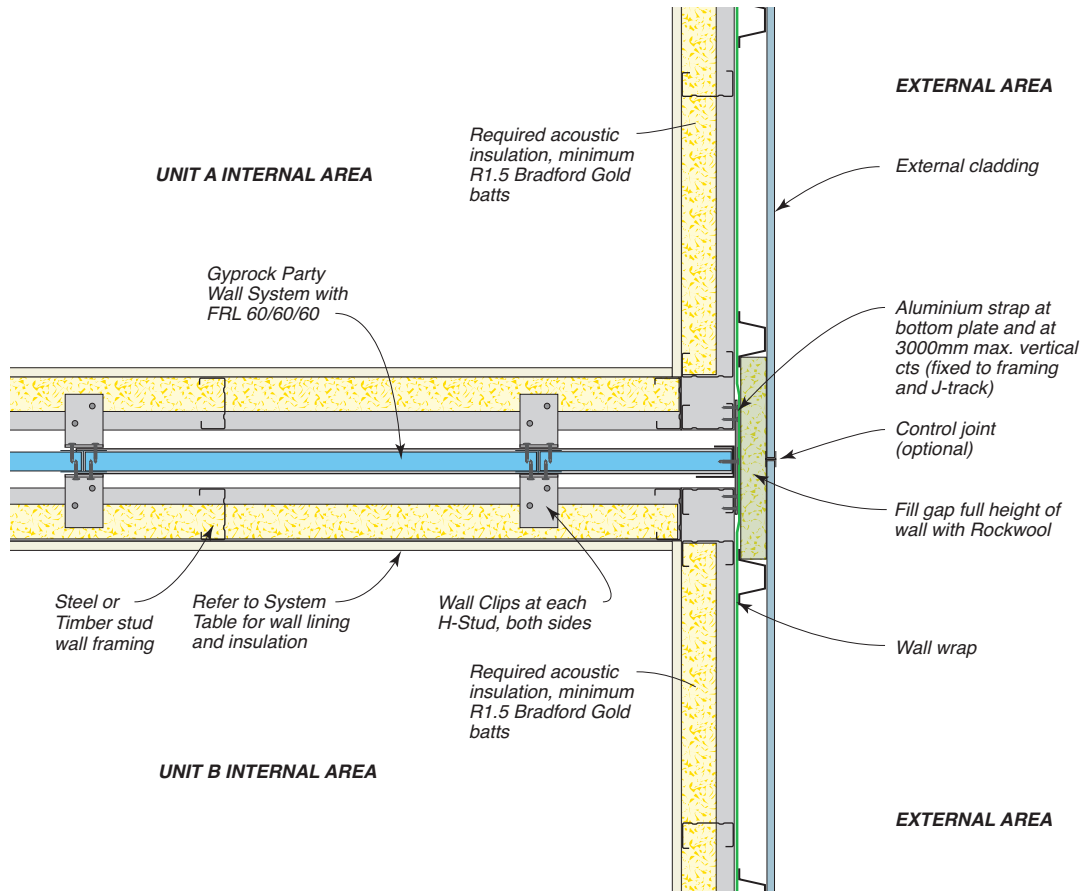

Figure 58: Junction Of Party Wall And External Brick Veneer Wall – Plan View

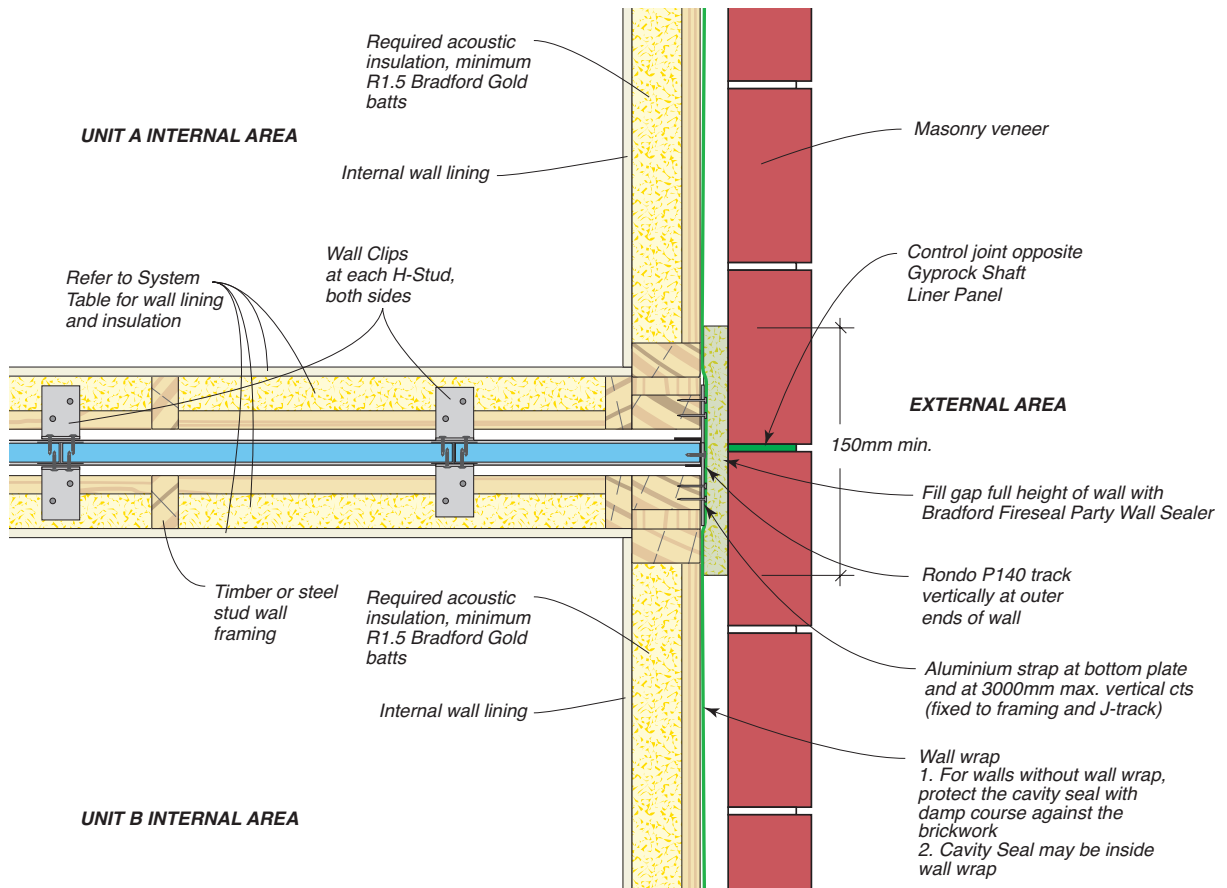

Figure 59: Junction Of Nib Party Wall And External Wall With Lightweight Cladding – Plan View

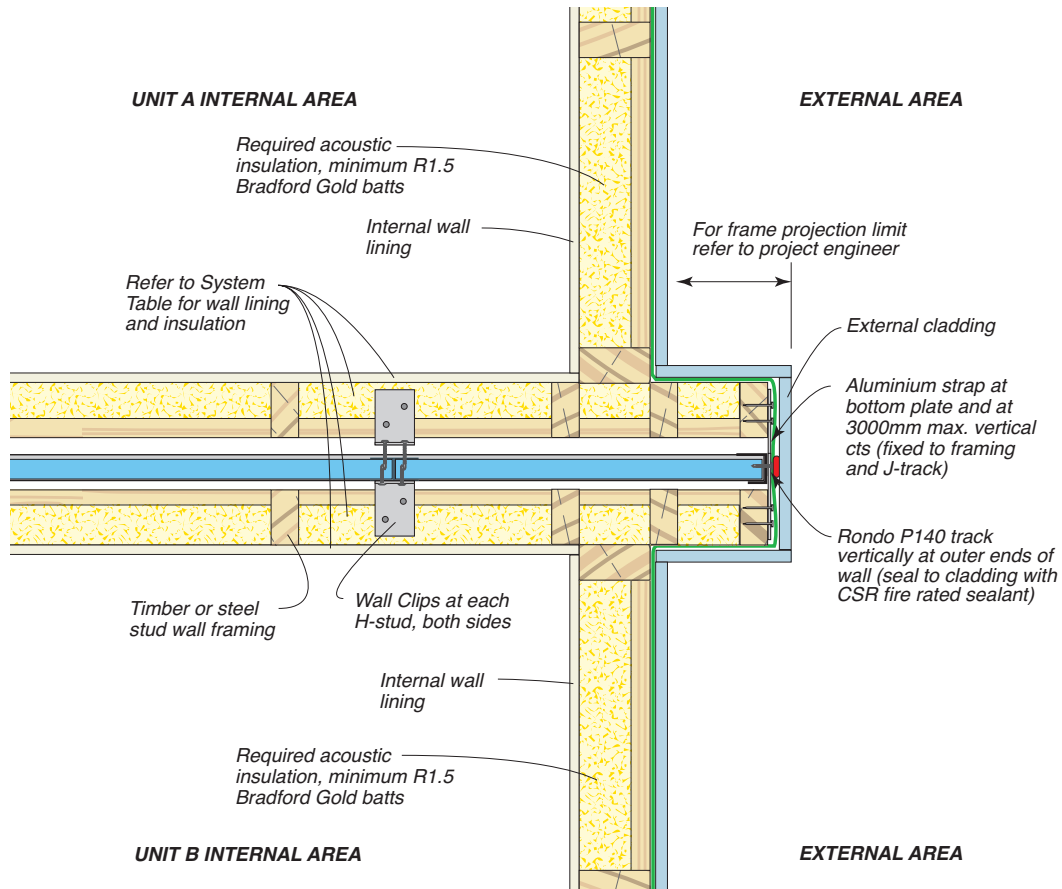

Figure 60: Junction Of Party Wall And External Wall With Brick Veneer At Wall Return – Plan View

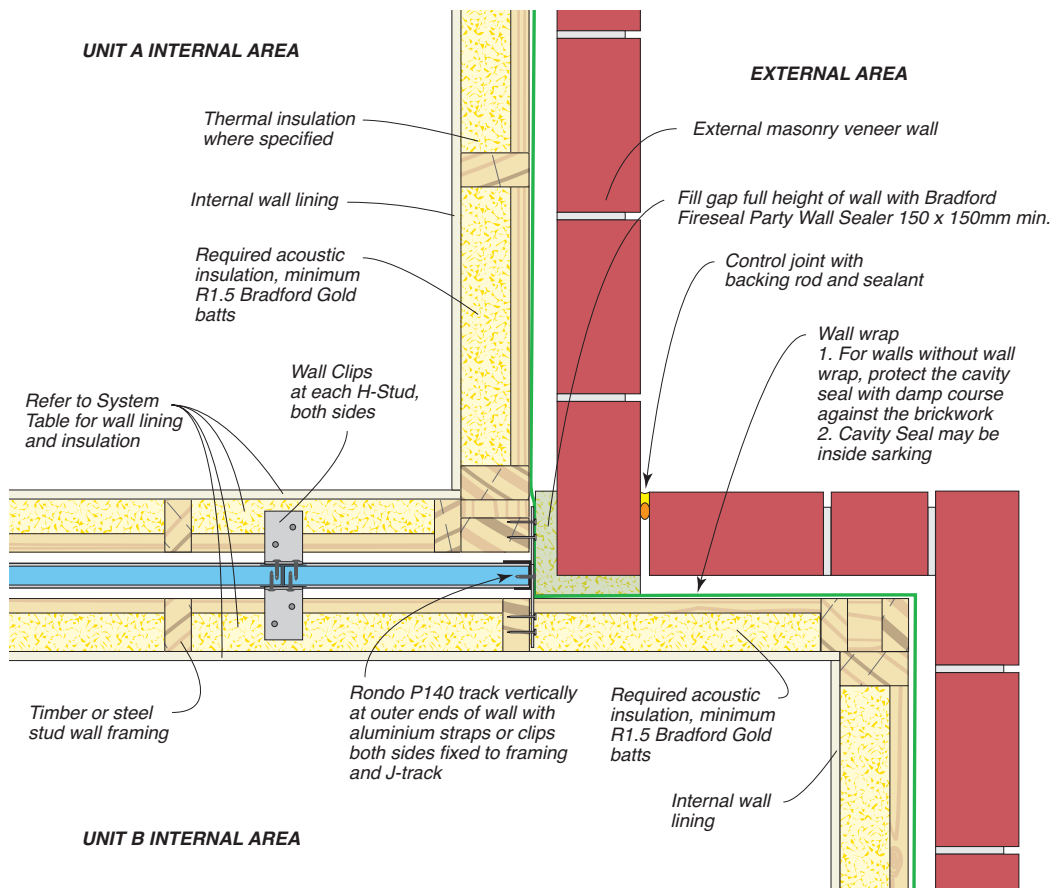

Figure 61: Junction Of Party Wall And External Wall With Lightweight Cladding At Wall Return – Plan View

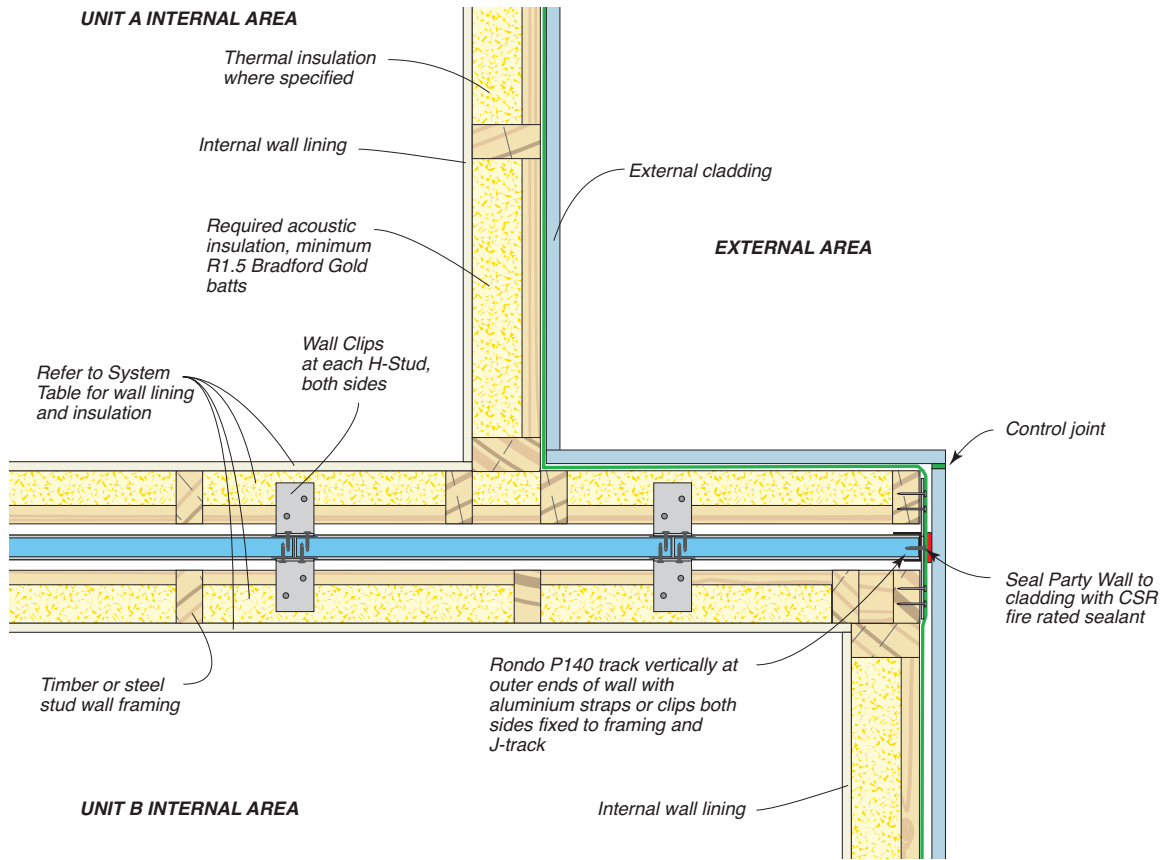

Figure 62: Junction Of Party Wall And External Wall With Lightweight Cladding At Wall Return – Cavity System – Plan View

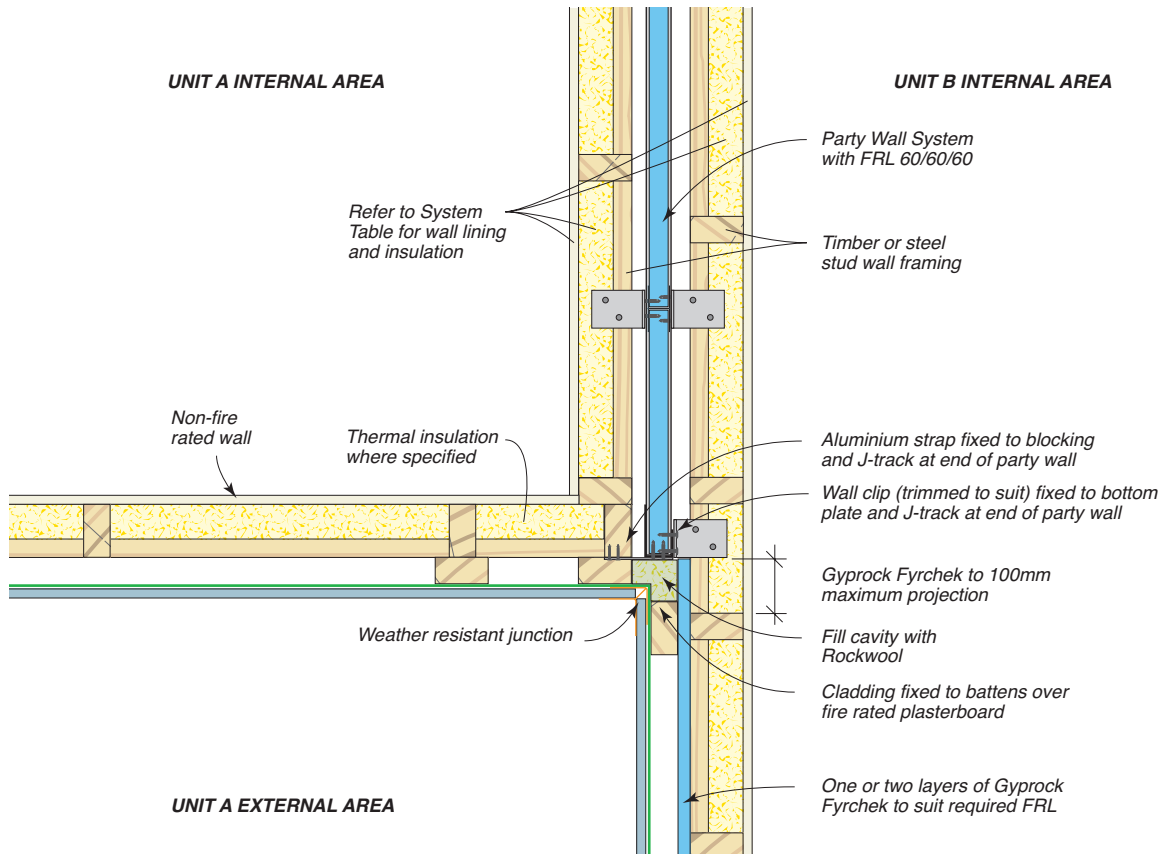

Figure 64: Junction Of Party Wall And External Wall With Lightweight Cladding System Direct Fixed to Framing – Plan View

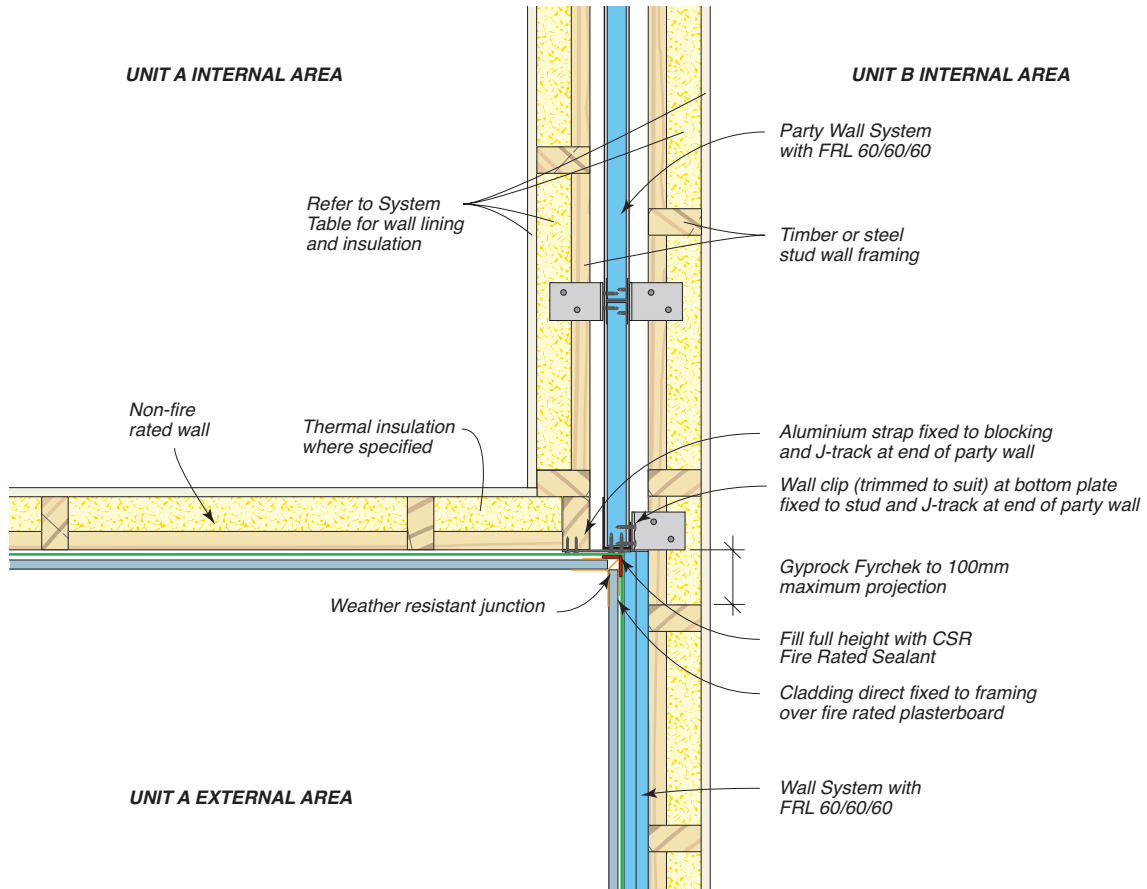

Figure 63: Junction Of Party Wall And External Wall With Cemintel Texture Base Sheet – Plan View

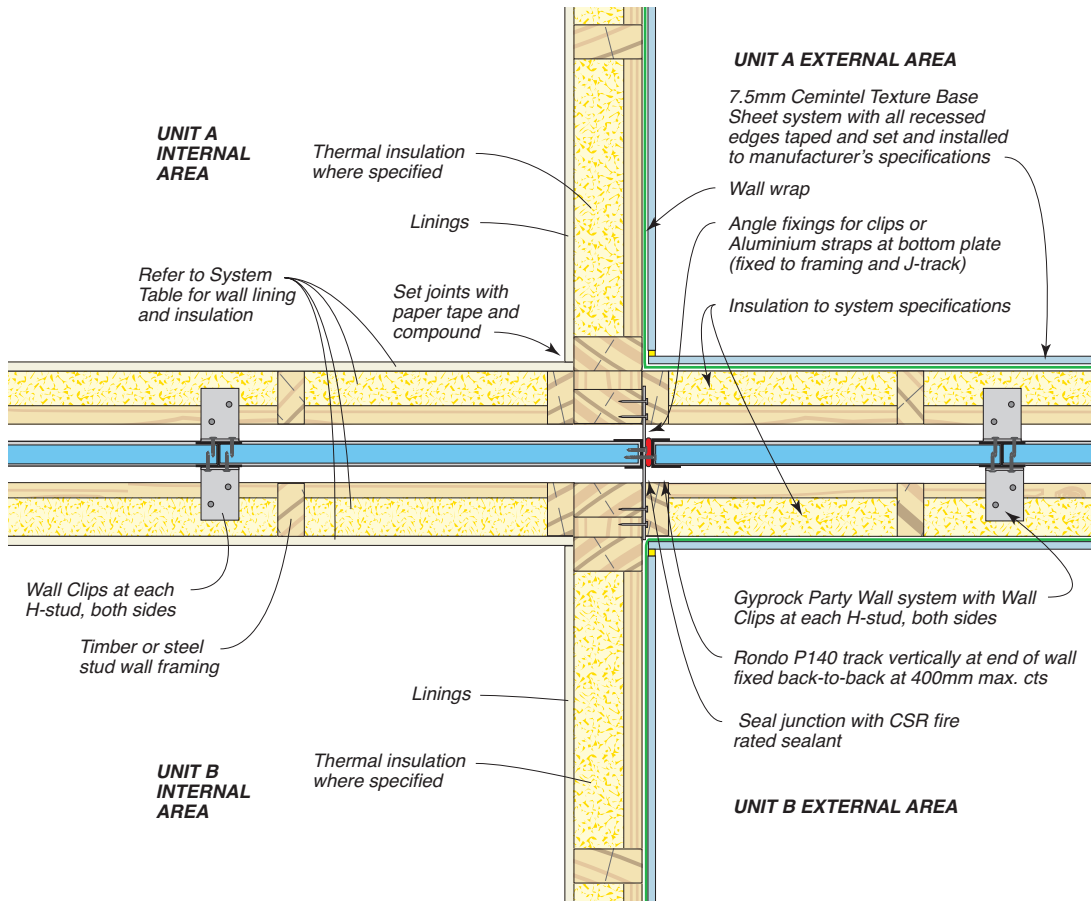

Figure 65: Junction Of Party Wall And External Wall With Aquacheck and Direct Fixed cladding – Plan View

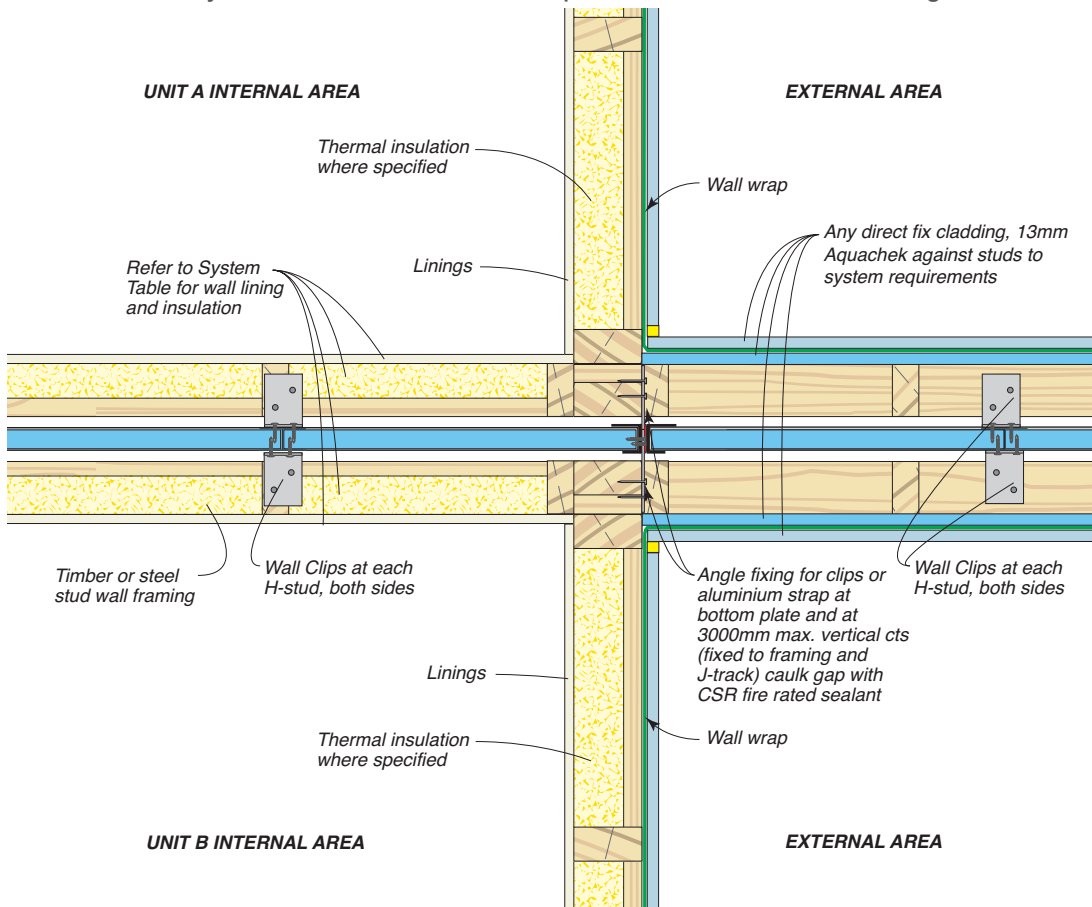

Figure 66: Cantilevered Construction Overview – Timber And Steel Framing

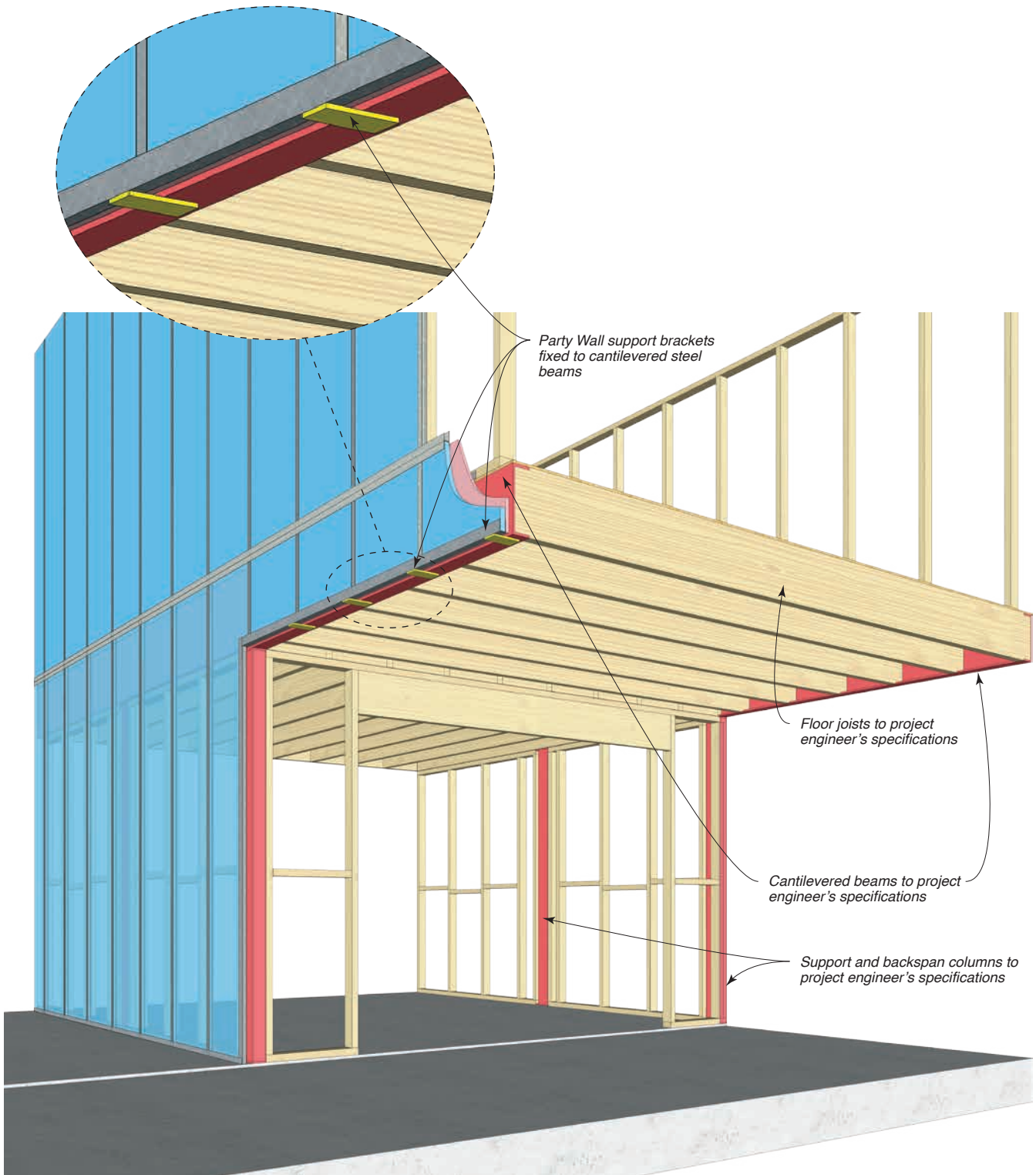

Figure 67: Cantilevered Level Soffit – With Cantilevered PFC Beams – End Elevation View

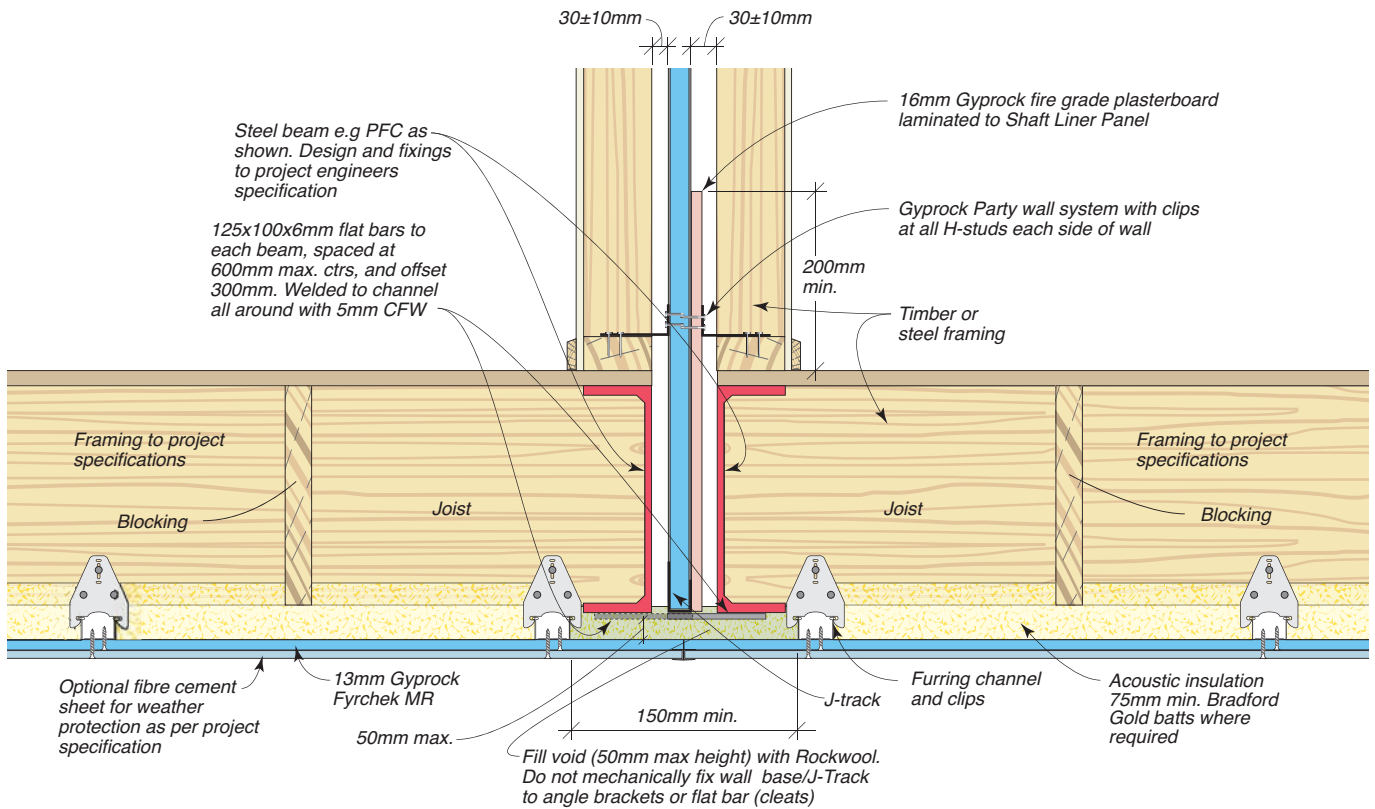

Figure 68: Cantilevered Stepped Soffit – With Cantilevered PFC Beams – End Elevation View

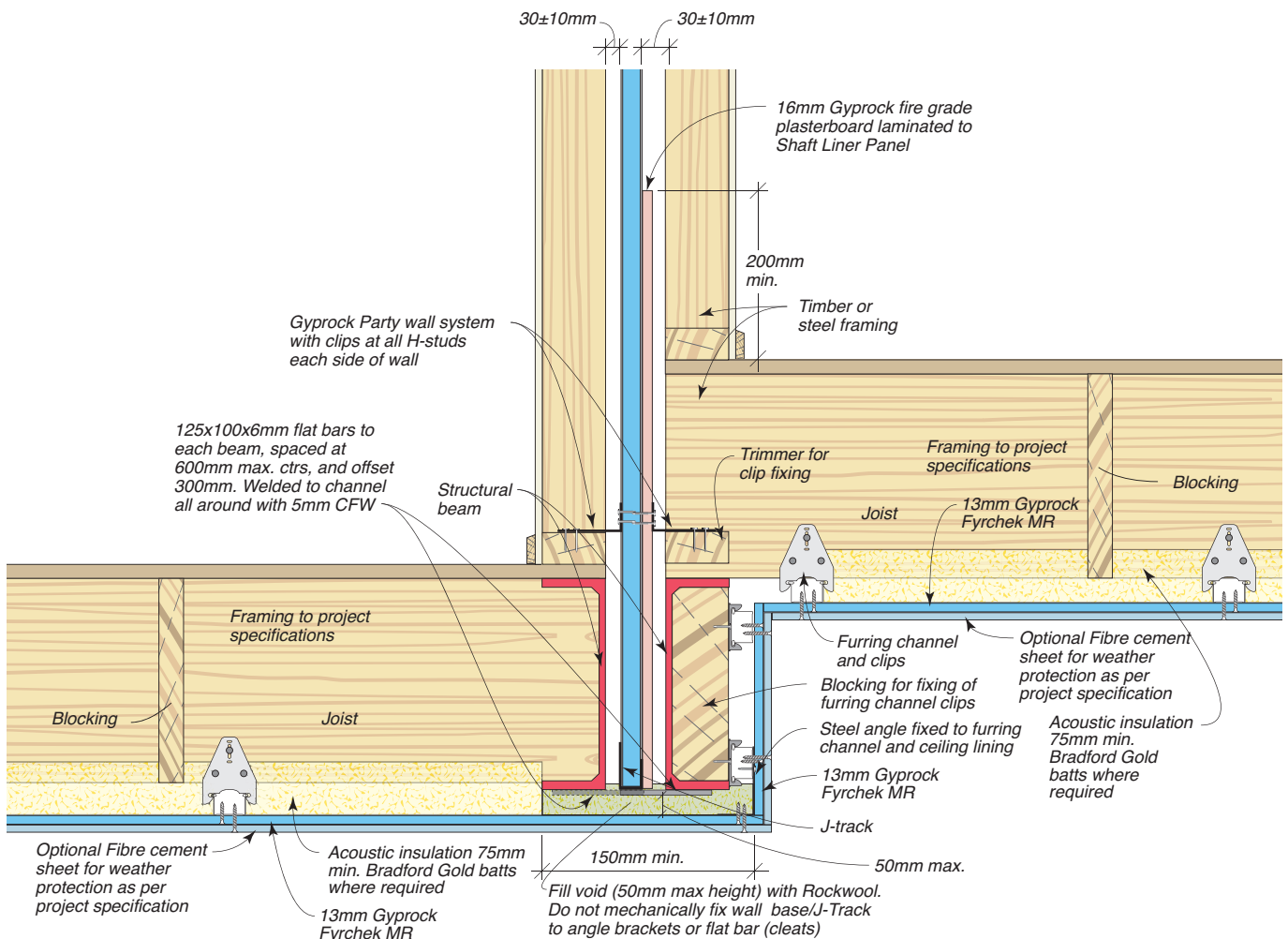

Figure 69: Cantilevered Level Soffit – With Cantilevered Timber Or Steel Joists – End Elevation View

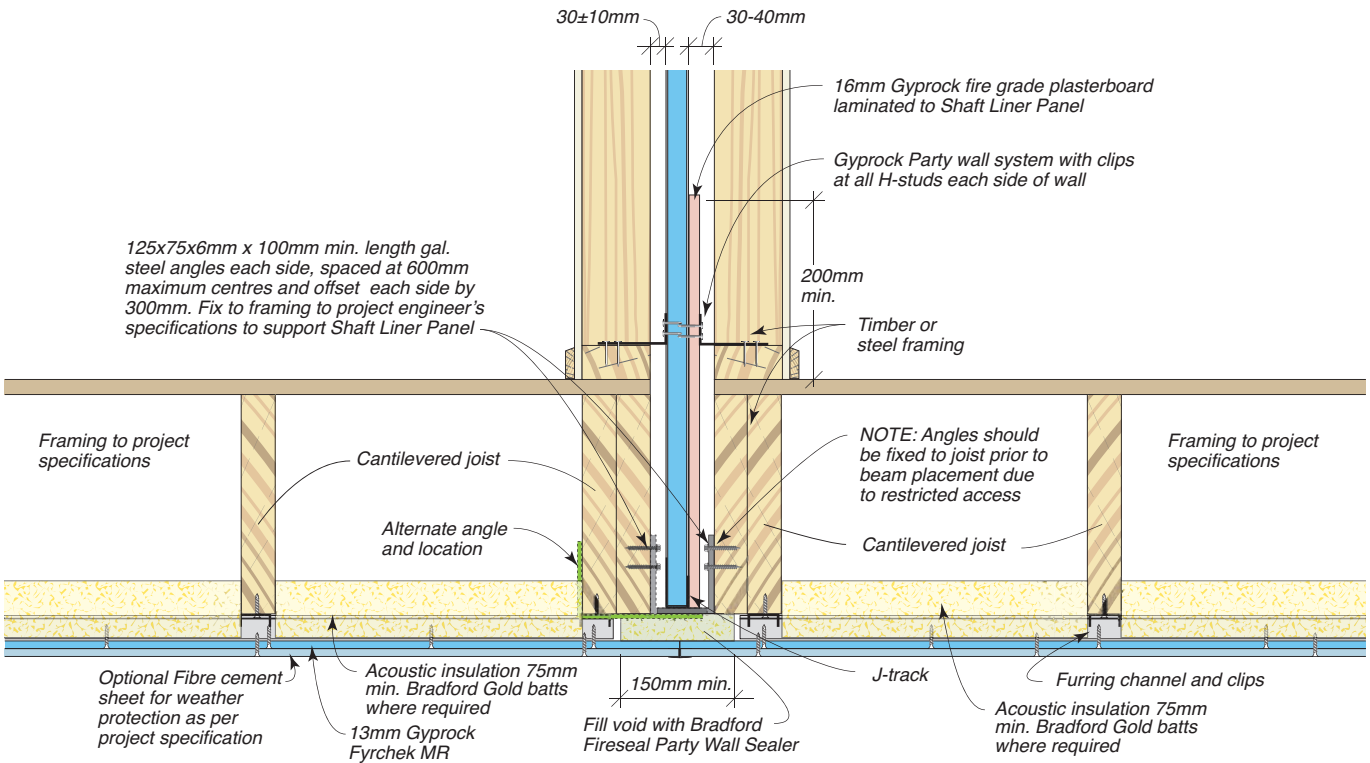
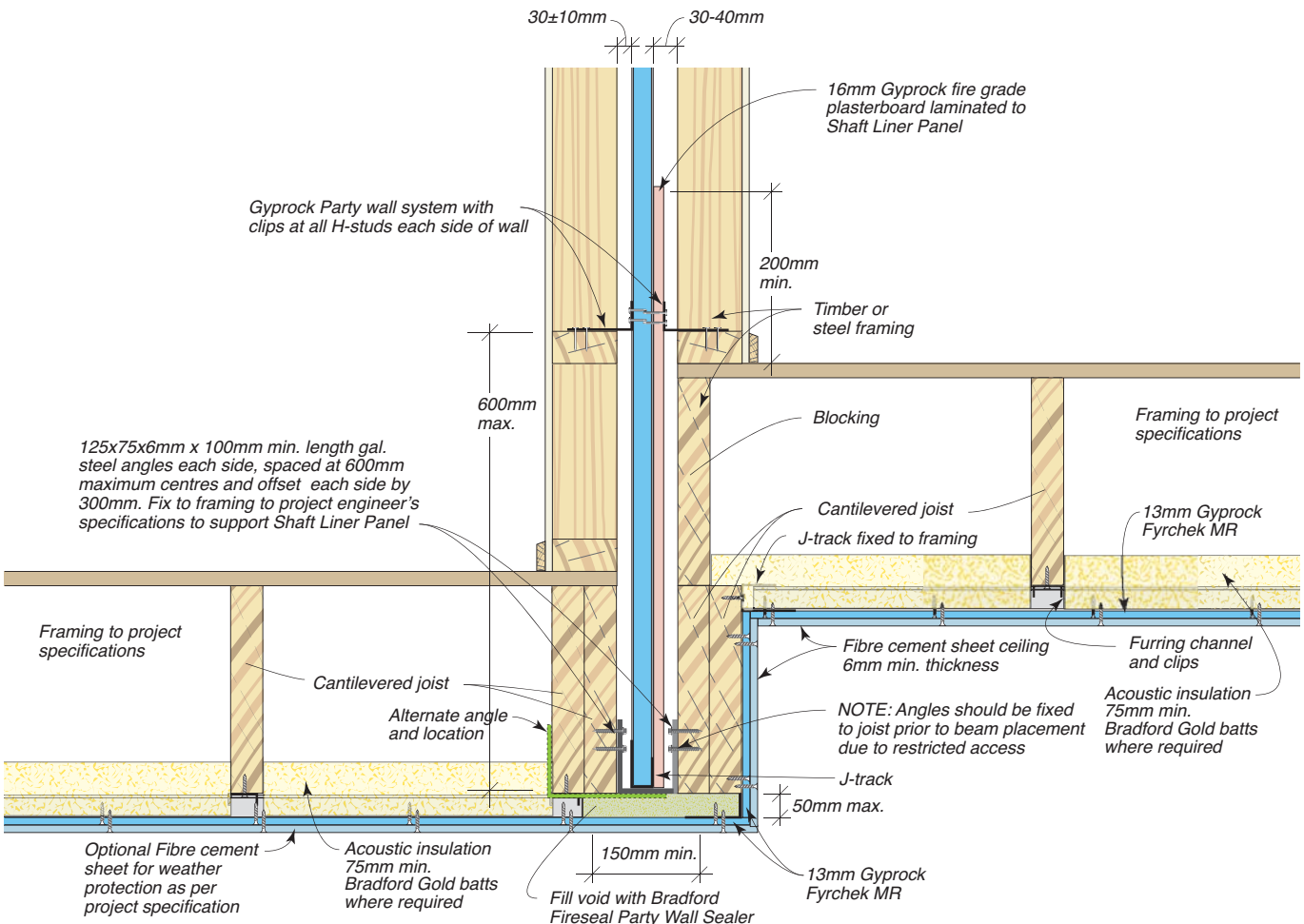

Figure 70: Cantilevered Stepped Soffit – With Cantilevered Timber Or Steel Joists – End Elevation View



Service Penetrations

Assessment FC13559, FRL as noted.

Metal pipes sizes are nominal outside dimension.

Cable sizes and arrangements are as noted.

Lagging is 25mm foil-faced rockwool batts or 25mm foil-faced SPI minimum density 100kg/m³ and 650°C nominal service temperature.

Service penetrations are permitted in roof spaces only.

Figure 71: Insulated Metal Pipe Penetration – FRL –/90/60

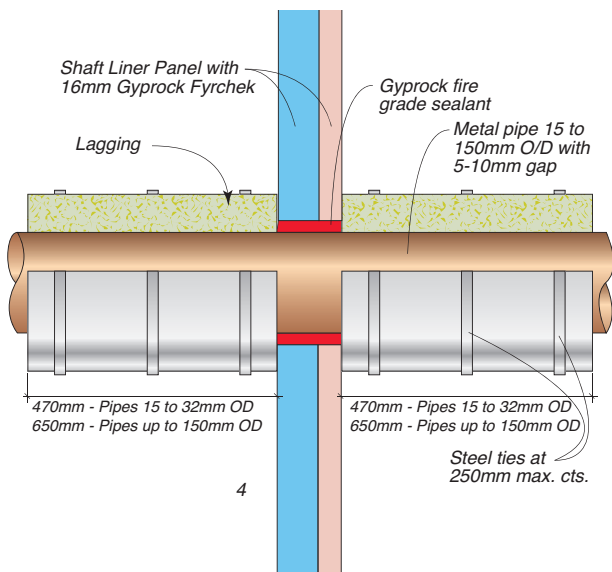

Figure 72: Metal Pipe Penetration – FRL –/90/–

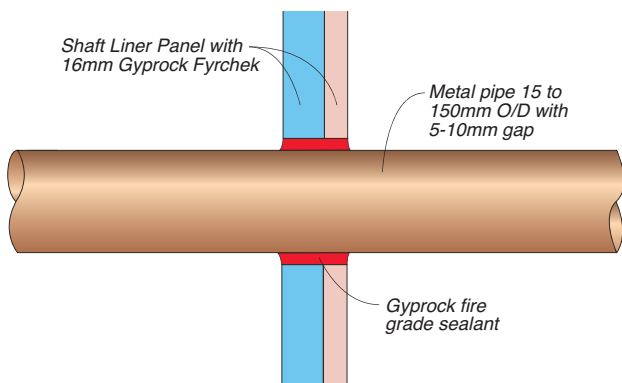

Table 4: Sample Cable Arrangements Per Penetration

Conductor area	Maximum Number
Three core x 1.5mm ²	4
Three core x 2.5mm ²	4
Three core x 6mm ²	1
Single core x 6mm ²	4

Figure 73: Insulated Electrical Cable Penetration – FRL –/90/60

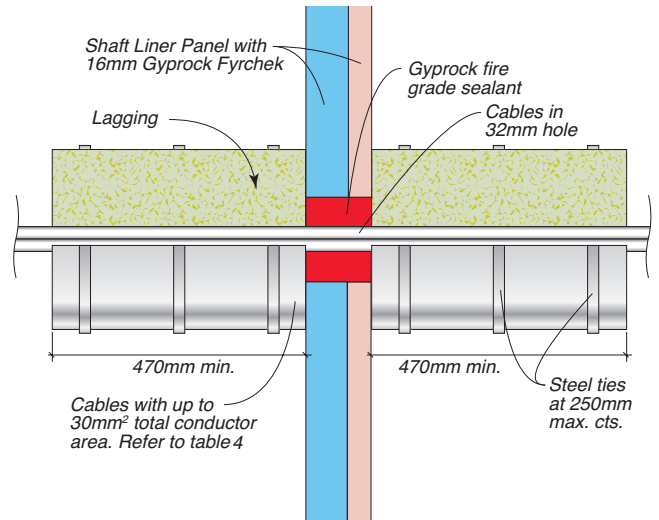

Figure 74: Electrical Cable Penetration – FRL –/90/–

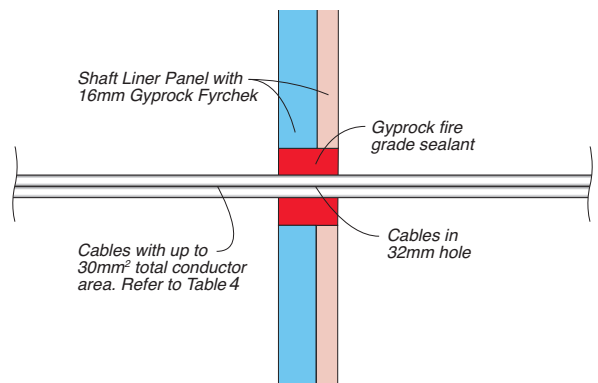
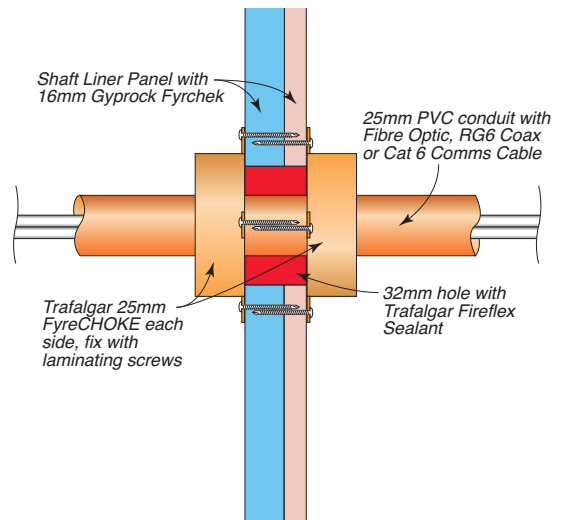

Figure 75: PVC Conduit with Communication Cable Penetration – FRL –/60/60



Party Wall Installation Checklist





Keep Party Wall system installation on track with this installation checklist, split by installation stage.



Date:
Builder:
Installer:
Project address:
Party Wall location:





Shaft Liner Framing and Panels	
Party Wall H-Studs have been used for vertical framing between panels, and back-to-back J-Tracks for horizontal framing between storeys.	<input type="checkbox"/>
Party Wall H-Studs align at each storey except in the roof space where an offset is permitted. J-Tracks are located within 600mm of Party Wall clip locations	<input type="checkbox"/>
Shaft Liner panels have been installed in a vertical orientation, except within 600mm of roof where horizontal panel installation is permitted.	<input type="checkbox"/>
Bradford Rockwool cavity seal (300mm minimum width) has been installed in the roof batten void at the top of the Shaft Liner Panel, and roof batten void depth does not exceed 50mm*	<input type="checkbox"/>
Wall end cavity voids between Shaft Liner Panels and back face of external cladding have been sealed with either CSR Bradford Rockwool cavity seal or CSR Gyprock Fire Mastic as required for cladding type	<input type="checkbox"/>
Bottom J-Track has been fixed to slab at 600mm centres with fixings commencing 150mm maximum from wall ends, or Party Wall Clips are used at the base of each H-Stud.	<input type="checkbox"/>
Fire sealant has been used where gaps occur between base track and slab.	<input type="checkbox"/>

Wall Cavity	
The cavity on both sides of the Party Wall, between wall framing and the central Shaft Liner Panel, is between 20 and 40mm (note that 16mm Fyrchek laminated to one side of the Shaft Liner is permitted within the cavity).	<input type="checkbox"/>

Party Wall Clip and Strap Placement	
Only Gyprock aluminium Party Wall clips and Straps have been used, and are correctly installed as follows:	
Clips are fixed to both sides of each H-Stud and to adjacent wall framing at a track or nogging.	<input type="checkbox"/>
Party Wall clips and straps are only located at ceiling and floor levels where discontinuous construction is required for acoustic impact performance between rooms . Party Wall clips and straps are fixed with not less than two screws or nails per end.	<input type="checkbox"/>
Party Wall vertical clip spacing does not exceed; 2.7m vertical centres for 2.7m or less Shaft Liner panel systems up to 14.0m total wall height OR 3.0m vertical centres for 3.0m or less Shaft Wall panel systems up to 12.0m total wall height OR 3.2m vertical centres for 3.2m or less Shaft Liner panel systems up to 10.8m total wall height OR 3.6m vertical centres for 3.6m or less Shaft Liner panel systems up to 9.0m total wall height	<input type="checkbox"/>
Party Wall clips have been installed a maximum of 600mm below vertical Shaft Liner Panel horizontal joints, or the top edge of the Shaft Liner Panel at underside of roof	<input type="checkbox"/>

Laminated 16mm Fyrchek Layer	
Ensure the following 16mm Fyrchek laminated layer installation requirements are observed:	
Laminated sheet edges must be neatly butted together with gaps not greater than 3mm, and do not require caulking	
Laminated sheet vertical joints to be offset from Shaft Liner H-Stud joints	
For FRL 60/60/60 systems; 16mm Fyrchek laminated sheet to be installed in all non-lined areas with top and bottom edges extending not less than 200mm beyond linings	
Gyprock laminating screws have been used to fix Fyrchek to the central Shaft Liner, with screws at 400x400mm or 500x300mm maximum spacing and 100mm maximum edge offset.	

Services and Service Penetrations	
Service penetrations do not pass through the central Shaft Liner panel, except within the roof cavity where penetrations may be fire sealed or installed in accordance with fire collar manufacturer's Shaft Liner fire tested details when required	
Outer wall lining service penetrations less than 65mm diameter are neatly formed with a 6mm maximum service clearance (note that fire caulking of outer wall lining service penetrations is not required)	
10mm minimum clearance has been provided between services and the central shaft liner with no services fixed to the Shaft Liner or H-Studs.	

Other Items	
Eaves space is sealed with CSR Gyprock Shaft Liner panel within P140 framing.*	
Roof framing, including complex roof forms such as hips and valleys, has been terminated on each side of the Party Wall to allow the central barrier to continue through to the underside of the roof.	
No doorways or openings pass through the Party Wall Shaft Liner or internal wall linings (including meter box recesses)	
Custom construction details such as transitions with other fire wall types must be fire engineered as an alternative solution and approved by the project Certifier or Building Surveyor	

Checklist points marked * are recorded in accordance with BCA installation requirements

Health & Safety

Information on any known health risks of our products and how to handle them safely is on their package and/or the documentation accompanying them.

Additional information is listed in the Safety Data sheet. To obtain a copy, telephone 1300 306 556 or visit www.gyprock.com.au.

Warranty

Gyprock products are designed to achieve optimal performance when part of a CSR integrated system.

CSR Building Products Limited warrants its Australian made Gyprock products to remain free of defects in material and manufacture for the usual lifetime of the product (25 years).

CSR warrants its International Alliance Gyprock products to remain free of defects in material and manufacture for 7 years.

For details on our product warranty, please visit www.gyprock.com.au, or contact us on 1300 306 556.

Contact Details

CSR Gyprock

www.gyprock.com.au
Telephone: 13 17 44
Facsimile: 1800 646 364

CSR DesignLINK Technical Support Service

Telephone: 1800 621 117
Facsimile: 1800 069 904
Email: designlink@csr.com.au

New South Wales and ACT

376 Victoria Street,
Wetherill Park NSW 2164

Queensland

768 Boundary Road,
Coopers Plains QLD 4108

Victoria

277 Whitehall Street,
Yarraville VIC 3013

South Australia

Lot 100 Sharp Court,
Mawson Lakes SA 5095

Western Australia

19 Sheffield Road,
Welshpool WA 6106

Tasmania

PO Box 61,
Glenorchy TAS 7010

Northern Territory

Cnr Stuart Hwy & Angliss St,
Berrimah NT 0828

GYPROCK®

Trinity 3, 39 Delhi Road, North Ryde, NSW 2113, Australia
CSR Building Products ABN 55 008 631 356



GYP513 FEBRUARY 2021 (BMS1817.0221V2)

CSR Gyprock, CSR Building Products A.B.N. 55 008 631 356.

The following are trade marks of CSR Limited and are under license. CSR, Gyprock®, Soundchek™, Aquachek™, Impactchek™, Superchek™, Fyrchek™, EC08™, Supaceil™, Bradford™, Martini™, DesignLINK™, Himmel™.

© CSR Limited 2021. Except as provided by the Copyright Act of 1968, no part of this publication may be reproduced in any form or by any means without the prior written permission of CSR Limited. Cover images of Vue Terrace Homes courtesy of Robina Group.

CSR